



GigaVUE-TA400 Hardware Installation Guide

GigaVUE TA Series

Product Version: 6.7

Document Version: 1.1

Last Updated: Friday, October 11, 2024

(See Change Notes for document updates.)

Copyright 2024 Gigamon Inc. All rights reserved.

Information in this document is subject to change without notice. The software described in this document is furnished under a license agreement or nondisclosure agreement. No part of this publication may be reproduced, transcribed, translated into any language, stored in a retrieval system, or transmitted in any form or any means without the written permission of Gigamon Inc.

Trademark Attributions

Gigamon and the Gigamon logo are trademarks of Gigamon in the United States and/or other countries. Gigamon trademarks can be found at www.gigamon.com/legal-trademarks. All other trademarks are the trademarks of their respective owners.

Gigamon Inc.
3300 Olcott Street
Santa Clara, CA 95054
408.831.4000

Change Notes

When a document is updated, the document version number on the cover page will indicate a new version and will provide a link to this Change Notes table, which will describe the updates.

Product Version	Document Version	Date Updated	Change Notes
6.7	1.1	10/11/2024	This update includes bug fixes and minor cosmetic changes for improved usability and document consistency.
6.7	1.0	06/05/2024	The original release of this document with 6.7 GA.

Contents

GigaVUE-TA400 Hardware Installation Guide	1
Change Notes	3
Contents	4
GigaVUE TA Series Overview	6
GigaVUE TA Series Nodes	7
GigaVUE TA Series Features and Benefits	9
Standard GigaVUE HC Series Features	10
Introducing the GigaVUE-TA400 Chassis	11
Chassis Cooling	13
Port LED's	13
Power LED	13
System LED's	14
Fan LED's	14
PSU LED's	14
GigaVUE-TA400 Rules and Notes	14
AMI BIOS Images	15
Air Flow Direction	16
Battery Caution	16
Précautions relatives à la pile	16
AC /DC Powered GigaVUE-TA400 Models	16
Breakout Modes	16
Configure the Port Mode	16
Breakout Panels	18
Getting Unpacked, Racked, Installed and Connected	18
Unpacking the GigaVUE TA Series Traffic Aggregator	18
Rack-Mounting the GigaVUE TA Series	19
Two-Post Rack Methods:	19
Four-Post Rack Methods:	20
Basic Connections and Configuration	23
Grounding the GigaVUE TA Series Chassis	24
Avoid Electrostatic Damage!	25
Connecting Power to the GigaVUE®TA Series	25
Connecting -48V DC Power Supplies	26
Cautions for Power and Ground connections	28

Précautions relatives au raccordement à l'alimentation et à la terre	29
Warning: Fiber Optic Port Safety	30
Avertissement : Sécurité du port fibre optique	30
Replacing Fans	30
Connecting Serial Console and Mgmt Ports	31
Configuring Basic Settings	32
Access the Command-Line Interface over the console Port	32
Advanced Features Licensing	36
Command-Line Basics	36
Command-Line Modes	36
Entering Commands in the CLI	37
Command-Line Syntax – Entering Commands	39
Config Mode Syntax	39
Paging through CLI Output	39
The Basic Commands	40
Completing the Initial Setup	42
Enter the Configure Command-Line Mode	43
SSH2	43
Advantages of SSH2	44
Changing Host Keys	44
Initial User Account Configuration	45
Configuring the GigaVUE TA Series Host Name	46
Configuring GigaVUE TA Series Node's Time Options	46
Setting Time Manually	47
Performing One-Time NTP Server Synchronization	47
Using NTP Time Server for System Clock Synchronization	47
Configuring Internet Explorer for Use with GigaVUE-FM	48
Configuring Automatic Email Notifications	48
Using a Custom Banner	50
Saving Changes	51
Connecting Ports on GigaVUE®TA Series	51
Transceiver—Rules and Notes	51
BiDi Optics Considerations	52
Transceiver Installation Instructions	52
MPO Cabling	52
MPO/MTP 12 Position Fiber Cable for Use with SR4 Transceivers	53
MTP/APC 12 Position Fiber Cable for Use with QSFP+ PLR4 Transceivers	53
MPO/MTP 24 Position Fiber Cable for Use with SR10 Transceivers	54
GigaVUE®TA Series Specifications	54
Physical Dimensions and Weight	54
Power Requirements	55
Fan Tray Specification for GigaVUE-TA400	55

Environmental Specifications	56
Compliance	56
Safety	56
Emissions	57
Immunity	57
Environmental	58
BSMI RoHS	58
VCCI	58
Warranty	59
Regulatory Labels	59
GigaVUE-TA400	59
NEBS Level 3 Compliance	60
Installation Instructions GigaVUE-TA400	60
Intrabuilding or Intra-connection for GigaVUE-TA400	60
Intrabuilding Ports (RJ45)	60
Class A2 Voltage Accessibility	60
Class B Voltage Accessibility	61
Equipment Grounding Systems	61
Communication Equipment Grounding	61
Bonding of Battery Return (BR) Input Terminals	61
Connections	61
Input AC/DC Voltage	62
Commercial Power Ports	62
Maintenance	62
Maintenance	62
Additional Sources of Information	63
Documentation	63
How to Download Software and Release Notes from My Gigamon	65
Documentation Feedback	66
Contact Technical Support	67
Contact Sales	67
Premium Support	68
The VUE Community	68
Glossary	69

GigaVUE TA Series Overview



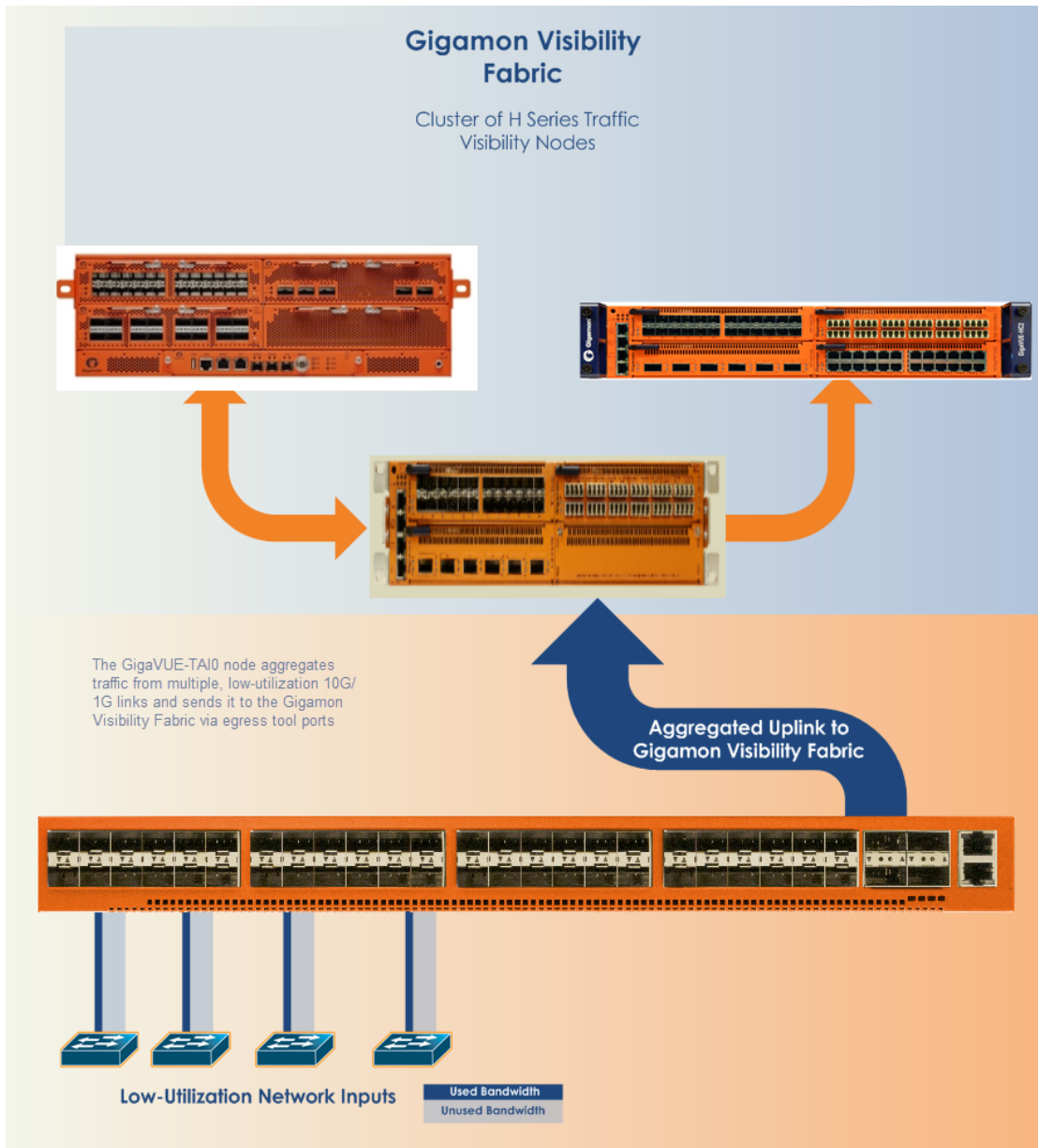

Gigamon's TA Series nodes allow you to aggregate the traffic from multiple low-utilization links before sending the traffic to the GigaVUE HC Series nodes that form your Gigamon Deep Observability Pipeline.

IMPORTANT: The GigaVUE TA Series support network, tool, clustering, and stack port connections to other GigaVUE TA Series nodes, including GigaVUE HC Series nodes.



GigaVUE TA Series Nodes

GigaVUE TA Series includes the following models:

<p>GigaVUE-TA25</p>	<ul style="list-style-type: none"> ▪ 1 RU Footprint ▪ 48 1Gb/10Gb/25Gb ports and 8 40Gb/100Gb ports, dual hot-pluggable power supplies (AC/DC), four rear hot swappable fan modules, two console ports, and a 10M/100M/1G management port. ▪ Optional patch or breakout panel support ▪ Cluster with HC Series nodes 	
<p>GigaVUE-TA25E</p>	<ul style="list-style-type: none"> ▪ 1 RU Footprint ▪ 48 1Gb/10Gb/25Gb ports and 8 40Gb/100Gb port, dual hot-pluggable power supplies (AC/DC), four rear hot swappable fan modules, two console ports, and a 10M/100M/1G management port. ▪ Optional patch or breakout panel support ▪ Cluster with GigaVUE HC Series nodes 	
<p>GigaVUE-TA100</p>	<ul style="list-style-type: none"> ▪ 1RU Footprint ▪ 32 40Gb/100Gb ports, dual hot-pluggable power supplies (AC/DC), hot swappable fan modules ▪ Optional patch or breakout panel support ▪ Cluster with GigaVUE HC Series nodes 	
<p>GigaVUE-TA200</p>	<ul style="list-style-type: none"> ▪ 2RU Footprint ▪ 64 40Gb/100Gb ports, dual hot-pluggable power supplies (AC/DC), hot swappable fan modules ▪ Optional patch or breakout panel support ▪ Cluster with GigaVUE HC Series nodes 	

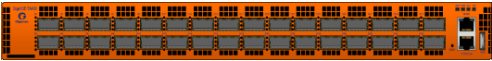
GigaVUE-TA200E	<ul style="list-style-type: none">▪ 2 RU Footprint▪ 64 QSFP28 ports (40Gb/100Gb), dual hot-pluggable power supplies (AC/DC) and hot swappable fan modules.▪ UART RS232 Console port (RJ45) and Management port (RJ45).	
GigaVUE-TA400	<ul style="list-style-type: none">▪ 1RU Footprint▪ 32 40Gb/100Gb/400Gb QSFP-DD/ QSFP28/QSFP+ ports, dual hot-pluggable power supplies (AC/DC), seven rear hot swappable fan modules, console port and a 10M/100M/1G management port.▪ Cluster with GigaVUE HC Series nodes	

GigaVUE TA Series Features and Benefits

GigaVUE TA Series nodes allow you to aggregate traffic from multiple network links from 1Gb up to 100Gb. The GigaVUE TA Series can pre-filter traffic for monitoring or be integrated into the GigaVUE HC Series cluster for end-to-end Flow Mapping® and management.

The GigaVUE HC Series and GigaVUE TA Series products share the same GigaVUE-OS software and are managed by GigaVUE-FM fabric manager for simplified operations. Traffic from any of these ports can be processed by GigaSMART traffic intelligence functions in GigaVUE HC Series devices to further optimize the traffic before it is sent to the tools.

GigaVUE TA Series nodes offer the following features and benefits:

- High-density visibility for 1Gb, 10Gb, 25Gb, 40Gb,100Gb and 400Gb.
- Low profile 2RU for GigaVUE-TA200 and GigaVUE-TA200E design offers easy deployment at the top of rack or end of row in data centers.
- Depending on the model, the GigaVUE TA Series supports a wide variety of Gigamon® transceivers. Transceivers purchased from other vendors are not supported.

- Optional patch panel or breakout panel allows use of 40Gb ports as four individual 10Gb ports on all the GigaVUE TA Series nodes, or 100Gb ports as four individual 25Gb ports on GigaVUE-TA200, GigaVUE-TA200E, GigaVUE-TA25, GigaVUE-TA25E or 400Gb ports as four individual 100Gb ports on GigaVUE-TA400.
- All ports of same type and speed can be used to create GigaStream.
- Front to back cooling.
- Fan modules.
- AC or DC power supply. Included with each node is the redundant second power supply.

Standard GigaVUE HC Series Features

In addition to the features described above, the GigaVUE TA Series offers many standard features from the GigaVUE HC Series nodes:

Benefit	Descriptions
Remote Management	<p>Configure the GigaVUE TA Series Traffic Aggregator's operations from a command-line interface:</p> <ul style="list-style-type: none"> • Local access over the serial console port. • Remote network access using SSH2 over the 1000 Ethernet Mgmt port. • Secure access to the CLI, either through local authentication or optional RADIUS/TACACS+/LDAP support. • Powerful and flexible logging, including event notification via syslog, email, and SNMP traps.
Aggregate Links	<p>Send the data from multiple different network ports to a tool port or GigaStream, allowing you to combine traffic from multiple access points into a single stream for uplink to the Gigamon Deep Observability Pipeline.</p>
CLI Management	<p>The GigaVUE TA Series nodes feature a common CLI with other GigaVUE HC Series nodes.</p>
Command Abbreviation	<p>Type only as many letters of a command as are needed to positively differentiate from other available commands. For example, you only need to type con t to enter Config mode, not the full configure terminal command.</p>
SNMP Support	<p>Rely on secure SNMP v3 access to the onboard SNMP agent as well as v1/v2 SNMP traps.</p>
Email Notifications	<p>Use email alerts for proactive notification of a wide variety of GigaVUE TA Series node events, helping you keep tabs on system status in real time.</p>
Scalable Port Density	<p>The GigaVUE-TA100 can have either sixteen (16), twenty-four (24), or thirty-two (32) 100Gb ports enabled. Licenses are available for the additional two sets of 8 ports.</p> <p>The GigaVUE-TA200 can have either thirty-two (32) or sixty-four (64) 100Gb ports enabled. A license is available for the additional 32 ports.</p> <p>The GigaVUE-TA200E can have either thirty-two (32) or sixty-four</p>

Benefit	Descriptions
	<p>(64) 40Gb/100Gb ports. A license is available for the additional 32 ports.</p> <p>The GigaVUE-TA25 has forty-eight (48) 1Gb/10Gb/25Gb ports and eight (8) 40Gb/100Gb ports enabled.</p> <p>A 24-port GigaVUE-TA25 called the GigaVUE-TA25A is also available. License is required to upgrade the GigaVUE-TA25A to include all 48 1Gb/10Gb/25Gb ports as well as the eight (8) 40Gb/100Gb ports .</p> <p>The GigaVUE-TA25E has forty-eight (48) 1Gb/10Gb/25Gb ports and eight (8) 40Gb/100Gb ports enabled.</p> <p>The GigaVUE-TA400 has 32 40Gb/100Gb/400Gb QSFP-DD/ QSFP28/QSFP+ ports and 7 rear hot swappable fan modules, console port and a 10M/100M/1G management port.</p> <p>The GigaVUE TA Series nodes make it easy to leverage the system’s 10Gb or 40Gb port density, aggregating multiple underused 1Gb/10Gb/40Gb network ports to 10Gb/40Gb tool ports for uplink to the Gigamon Deep Observability Pipeline.</p>
Clustering	<p>The GigaVUE-TA100, GigaVUE-TA200, GigaVUE-TA200E nodes, GigaVUE-TA25 , GigaVUE-TA25E and GigaVUE-TA400 can cluster with other GigaVUE HC Series nodes.</p> <p>The GigaVUE-TA400 can cluster with all GigaVUE HC Series nodes and GigaVUE TA series nodes only with E-tag mode.</p> <p>This allows you to take advantage of the benefits of features such as GigaSMART.</p>
Ingress VLAN Tagging	<p>VLAN Tags can be added to the ingress packets on a per-port basis. This can help identify, differentiate or track incoming sources of traffic.</p>
GigaVUE-FM (Centralized Management System)	<p>Use the centralized GigaVUE TA Series Fabric Management System to review, configure, and update GigaVUE TA Series just like other GigaVUE HC Series.</p>

Introducing the GigaVUE-TA400 Chassis

The GigaVUE-TA400 chassis consists of a 1RU, rack-mountable, 32 of 400Gb/100Gb/ 40Gb QSFP-DD/ QSFP28/QSFP+ ports, dual hot-pluggable power supplies (AC/DC), seven hot swappable fan modules at the rear, console port and a 10M/100M/1000M management port. The below figure shows the ports at the front of the GigaVUE-TA400 chassis. Refer to [GigaVUE-TA400 Ports](#) for a description of each of the ports.

GigaVUE-TA400 Front View

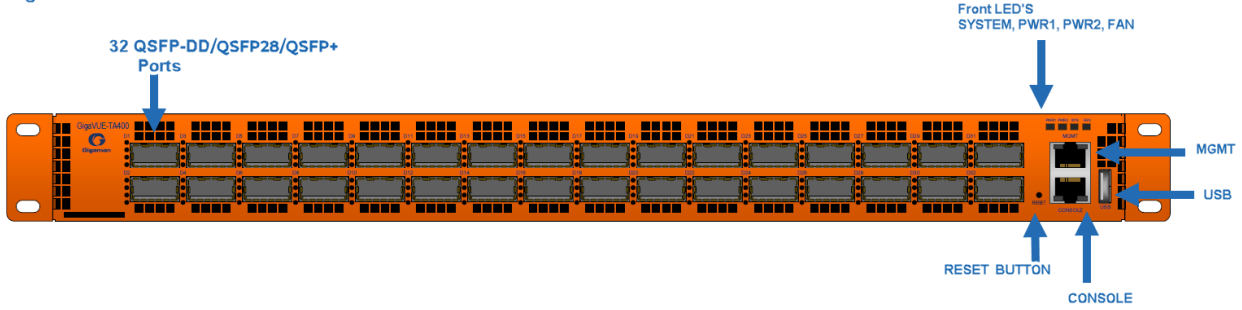

GigaVUE-TA400 Rear View

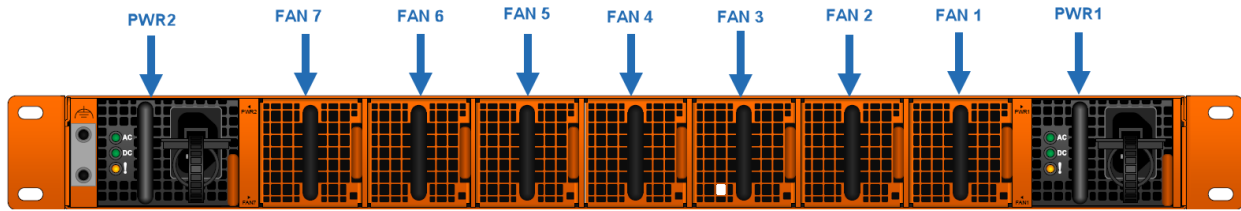

Table 1: GigaVUE-TA400 Ports

Port	Description
Management	Use the Mgmt port for remote configuration of GigaVUE-TA400 Traffic Aggregator over a 10M/100M/1000M Ethernet network. Refer to installation guide for information on establishing an SSH configuration session with the GigaVUE-TA400 Traffic Aggregator.
Console	Use the Console port for local configuration of the GigaVUE-TA400 Traffic Aggregator over a serial connection. Refer to installation guide for information on establishing a serial configuration session with the GigaVUE-TA400 Traffic Aggregator in a terminal window.
Ports D1..D32	The GigaVUE-TA400 provides 32 400Gb/100Gb/ 40Gb QSFP-DD/ QSFP28/QSFP+ ports. All ports support 4x100G breakouts D1C1..D32C4 with QSFP-DD DR4, DR4+(XDR4) optics and 4x25G, 4x10G breakouts D1X1..D32X4 with QSFP28, QSFP+ optics. For details about the supported transceivers and cable type, refer to the "GigaVUE Interoperability Matrix".
Transceivers	Below listed breakout connections are supported and validated. <ul style="list-style-type: none"> 400G-DR4-QDD-511 breakout connections to 4x100G QSFP28-511-DR1 400G-DR4+-QDD-512 breakout connections to 4x100G QSFP28-514-FR1 For details about the supported transceivers and cable type, refer to the GigaVUE Interoperability Matrix

Chassis Cooling

The fans on the GigaVUE-TA400 run at 100% of their maximum speed on power up, then drop to approximately 60% during normal operations. The temperatures of four components: transceivers, exhaust, CPU, and switch CPU, are monitored. When a component crosses a pre-defined threshold, the fan speed is adjusted dynamically, in increments of approximately 10%.

An SNMP trap is sent when a component reaches the threshold for warning or critical temperature conditions. Refer to [Component Temperature Thresholds and Actions](#) for the temperatures at which the warning and critical traps are sent and any additional action that occurs at a threshold.

Table 2: Component Temperature Thresholds and Actions

Transceiver Temperature	Intake Temperature	Exhaust Temperature	CPU Temperature	Switch CPU Temperature
70°C	85°C	85°C	90°C	95°C
Warning trap sent	Warning trap sent	Warning trap sent	Warning trap sent	Warning trap sent
80°C	90°C	90°C	95°C	100°C
Alert trap sent; Transceiver power disabled	Alert trap sent	Alert trap sent	Alert trap sent	Alert trap sent; Switch CPU put in reset
95°C	95°C	95°C	100°C	105°C
Critical trap sent	Critical trap sent	Critical trap sent	Critical trap sent	Critical trap sent

The output of the following CLI command displays the transceiver temperature:

```
TA400 (config) # show port params port-list 1/1/d3,1/1/d26
Parameter          1/1/d3          1/1/d26
SFP Power (1-2) (dBm):  1.30  1.47  0.87  0.49
SFP Power (3-4) (dBm):  2.45  1.50  1.08  0.77
SFP Power (5-6) (dBm):  -      -      -      -
SFP Power (7-8) (dBm):  -      -      -      -
SFP Power (9-10) (dBm): -      -      -      -
SFP Temperature (C):   38.00          42.00
```

Port LED's

The port LEDs status are as follows:

- Solid GREEN indicates that the link is operationally up
- Blinking GREEN indicates the port is operationally up and there is traffic flowing through the port
- Solid AMBER indicates that the port is administratively disabled.
- Off indicates link is operationally down.

Power LED

The power LED on the front of the chassis (PWR1 and PWR2) are as follows:

- Solid GREEN indicates that the power supply unit (PSU) has power and is operating normally.
- Blinking AMBER indicates that the PSU is removed.
- Solid AMBER indicates that the PSU has failed.
- Off indicates that the PSU is disconnected.

System LED's

The system LED on the front of the chassis (SYS) is as follows:

- Off indicates no power.
- Blinking GREEN indicates the node is booting.
- Solid GREEN indicates normal operation.
- Solid AMBER indicates the system has failed.

Fan LED's

The fan LED on the front of the chassis is as follows:

- Solid GREEN indicates all fans are operating normally.
- Solid AMBER indicates fan has failed.

The fan LED at the rear of the chassis is as follows:

- Solid GREEN indicates fan is operating normal.
- Solid AMBER indicates fan module failed.

PSU LED's

The individual power LEDs on the rear of the chassis are as follows:

- GREEN indicates the PSU is operating normally and is receiving good AC input.
- Solid AMBER indicates the PSU is not operational and is not receiving any AC input.

GigaVUE-TA400 Rules and Notes

Keep in mind the following notes and rules when using the GigaVUE-TA400:

GigaVUE-TA400 Notes	
Transceivers	For details about the supported transceiver, cable type, and connectivity specifications, refer to "GigaVUE-OS Compatibility and Interoperability Matrix".
Network, Tool, Hybrid, Port	Any port on GigaVUE-TA400 can be used as network, tool and hybrid ports.
Stack-Links	Stacking is supported on GigaVUE-TA400 from the 5.16 release in E-tag mode clustering.

GigaVUE-TA400 Notes	
Map Rules and Port Filters	GigaVUE-TA400 supports 256 map rules, 20 egress port filters per chassis by default without advance feature license. The outer VLAN tool port filter to match the ingress VLAN tag and IP fragmentation tool port filters are supported on GigaVUE-TA400 starting from 5.15 release. For details about the maximum map rules, refer to the "Maximum Map Rules" table in the GigaVUE-FM Users Guide. The port filter having VLAN and IPv6 fields is not supported except with individual fields.
Header Stripping	VXLAN, L2 MPLS and L3 MPLS header stripping features are supported on GigaVUE-TA400 starting from 5.15 release.
Tunneling	Layer 2 Generic Routing Encapsulation (L2GRE) and Virtual Extensible LAN (VXLAN) Tunneling features are supported on GigaVUE-TA400 starting from 5.15 release.
Port Licensing	On the GigaVUE-TA400, all 32 ports are enabled. Port license is not required.
Cluster Licensing	Connecting a GigaVUE-TA400 to an E-tag cluster requires the Advanced Features License.
Inline Bypass Feature	GigaVUE-TA400 does not support Inline Bypass feature.

AMI BIOS Images

The GigaVUE-TA400 has an AMI Basic Input/Output System (BIOS). The BIOS image is packaged with the software image. The BIOS contents are stored in flash memory, allowing the BIOS to be upgraded. There are two flash components, a primary and a secondary.

The following CLI command displays the two flash components and indicates the BIOS image from which the system booted using asterisks:

```
(config) # show version
...
1st flash version: amibios-ta400-1.1.0 Tue. Oct. 5 10:19:55 UTC 2021 **
2nd flash version: amibios-ta400-1.1.0 Tue. Oct. 5 10:19:55 UTC 2021
SW BIOS version:  amibios-ta400-1.1.0 Tue. Oct. 5 10:19:55 UTC 2021
...
```

If there is a component failure in the primary flash, the GigaVUE-TA400 boots from a backup golden BIOS image in the secondary flash. An SNMP trap can be configured to be sent when the system has booted from the secondary flash. The trap may indicate that the primary flash component needs to be serviced. The trap is as follows:

```
2ndflashboot: Secondary flash boot notification
```

Air Flow Direction

The air flow direction is from the front of the GigaVUE-TA400 chassis to the rear. The rear-mounted fans pull air from the front to the back of the chassis. For environments with hot/cold aisles, install the chassis so the intake air at the front of the chassis is cold.

Battery Caution

GigaVUE-TA400 is equipped with a disposable, non-rechargeable, Real Time Clock (RTC) Lithium metal coin cell battery. Note the following:

- There is a risk of fire if the battery is replaced with an incorrect type.
- Use only CR-2032L type Lithium metal coin cell battery and replace with the same.

Précautions relatives à la pile

Une pile bouton Lithium métal jetable, non rechargeable, pour l'horloge en temps réel (RTC) est

présente dans le GigaVUE-TA400. Veuillez noter les points suivants :

- Il existe un risque d'incendie si la pile est remplacée par un type incorrect.
- Utilisez uniquement une pile bouton CR-2032L type Lithium métal et remplacez-la par le même type

AC /DC Powered GigaVUE-TA400 Models

Gigamon provides both AC/DC powered versions of the GigaVUE-TA400 Traffic Aggregator.

Breakout Modes

GigaVUE-TA400 allows port breakout mode. Refer to [Configure the Port Mode](#) for further details.

Configure the Port Mode

The port breakout modes are as follows:

- **4x10Gb**—Specifies the **4x10Gb** port breakout mode. This mode applies to GigaVUE-TA400 nodes. This mode provides a 4 x 10Gb breakout option for 40Gb ports.

- **4x25Gb**—Specifies the **4x25Gb** port breakout mode. This mode applies to GigaVUE-TA400 nodes. This mode provides a 4 x 25Gb breakout option for 100Gb ports.
- **4x100Gb**—Specifies **4x100Gb** port breakout mode. This mode applies to GigaVUE-TA400 nodes. This mode provides a 4x100Gb breakout option for 400Gb ports
- **none**—Specifies no port breakout mode. This is the default mode for GigaVUE TA Series nodes.

Any ports in GigaVUE-TA400 can operate at 40Gb with QSFP+ SR transceivers.

A 40Gb port can be broken out into four 10Gb ports, called subports. The subports will all have the same speed (10Gb). Subports will have x1 to x4 appended to their port ID, for example, when port 1/1/d2 on GigaVUE-TA400 is configured to 4x10Gb mode, the subports will be: 1/1/d2x1, 1/1/d2x2, 1/1/d2x3, and 1/1/d2x4.

In **4x10Gb** mode, the subports can function as network, tool, stack, circuit and hybrid ports. GigaStream port members can be activated in the tool, stack, and hybrid port types. Subports on GigaVUE-TA400 can also function as stack ports.

- The maximum number of 10Gb subports on a GigaVUE-TA400 is 128 (32 x 4)

The 100Gb QSFP28 ports (1/1/d1 to 1/1/d32) on the GigaVUE-TA400 can be broken out into four 25Gb ports, called subports.

The subports will have the same speed (25Gb). Subports will have x1 to x4 appended to their port ID, for example, when port 1/1/d2 on GigaVUE-TA400 is configured to 4x25Gb mode, the subports will be: 1/1/d2x1, 1/1/d2x2, 1/1/d2x3, and 1/1/d2x4.

- The maximum number of 25Gb subports on a GigaVUE-TA400 is 128 (32 x 4).

In **4x25Gb** mode, the subports can function as network, tool, stack, circuit and hybrid ports. GigaStream port members can be activated in the tool, stack, and hybrid port types. Subports on GigaVUE-TA400 can also function as stack ports.

The 400Gb QDD ports (1/1/d1 to 1/1/d32) on the GigaVUE-TA400 can be broken out into four 100Gb ports, called subports.

The subports will have the same speed (100Gb). Subports will have c1 to c4 appended to their port ID, for example, when port 1/1/d2 on GigaVUE-TA400 is configured to 4x100Gb mode, the subports will be: 1/1/d2c1, 1/1/d2c2, 1/1/d2c3, and 1/1/d2c4.

In **4x100Gb** mode, the subports can function as network, tool, stack, circuit and hybrid ports. GigaStream port members can be activated in the tool, stack, and hybrid port types. Subports on GigaVUE-TA400 can also function as stack ports.

- The maximum number of 100Gb subports on a GigaVUE-TA400 is 128 (32 x 4)
- Below listed breakout connections are supported and validated.
 - 400Gb-DR4-QDD-511 breakout connections to 4x100Gb QSFP28-511-DR1
 - 400Gb-DR4+-QDD-512 breakout connections to 4x100Gb QSFP28-514-FR1.

There are rules for configuring parent ports and subports. For more information, refer to the port command in the reference section of the GigaVUE-OS CLI Reference Guide. Once the port breakout mode has been configured, refer to [Breakout Panels](#).

For further information refer to GigaVUE-OS Compatibility and Interoperability Matrix.

Breakout Panels

Breakout panels let you connect ports on a GigaVUE TA Series node to a tool or network port or TAP for port breakout or aggregation.

The following breakout panels are available:

- PNL-M341/PNL-M341T
- PNL-M343/PNL-M343T

Refer to [G-TAP M Series Hardware Guide](#) for details.

Getting Unpacked, Racked, Installed and Connected

The following steps are required to get a GigaVUE TA Series Traffic Aggregator mounted and running:

Unpacking the GigaVUE TA Series Traffic Aggregator

1. Unpack the GigaVUE TA Series Traffic Aggregator and inspect the box it was shipped in. If the carton was damaged, please file a claim with the carrier who delivered it.
2. Remove the protective shipping covers and screws. Save the protective shipping covers and replace the screws in the holes on the system so that they are easily saved in case you need to ship the system again.
3. Next, select a suitable location for the rack unit that will hold the GigaVUE TA Series Traffic Aggregation node. Choose a location that is clean, dust free, and well ventilated. You will need access to a grounded power outlet. Avoid areas where heat, electrical wire, and electromagnetic fields are generated.

4. Plan for enough clearance in front of a rack so you can open the front door completely (approximately 25in) and enough clearance in the back of the rack to allow sufficient airflow.

Rack-Mounting the GigaVUE TA Series

Safety Precautions

There are a wide variety of racks available on the market. Consult the instructions provided by the rack vendor for detailed mounting instructions before installing the GigaVUE TA Series Traffic Aggregation node.

NOTE: Before rack-mounting the GigaVUE TA Series, please read the following safety precautions:

- Install any stabilizers provided for the rack before installing the chassis. Unsecured racks can tip over.
- Install boxes in the rack from the bottom up with the heaviest boxes at the bottom.
- Ensure adequate ventilation to the systems installed in the rack.

This section describes how to rack-mount the GigaVUE TA Series Traffic Aggregation node in a standard 1RU rack space using the hardware provided with the chassis. The node mounts in an EIA-standard 19in or 24in telco rack or equipment cabinet, up to 39in deep.

GigaVUE TA Series Traffic Aggregation nodes are shipped with rack ears for front-mounting or rear-mounting ([Figure 1 GigaVUE TA Series Traffic Aggregator Rack Ears in Front-Mount Position](#)) in either a two-post or four-post rack.

Two-Post Rack Methods:

Most GigaVUE TA Series Traffic Aggregation nodes can either be front mounted or rear mounted using the rack ears as shown below. GigaVUE-TA200, GigaVUE-TA25 and GigaVUE-TA400 can only be front mounted.

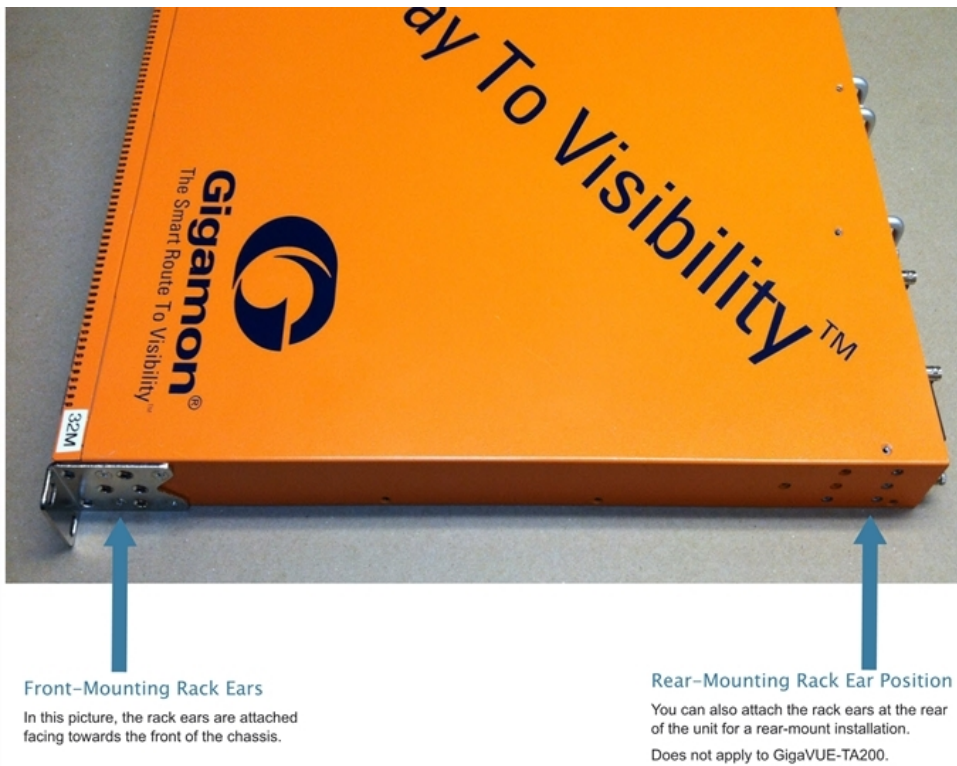

Figure 1 GigaVUE TA Series Traffic Aggregator Rack Ears in Front-Mount Position

To mount the GigaVUE TA Series Traffic Aggregation node in a rack:

1. Attach the orange rack ears to the front or rear of the unit (rear mounting does not apply to GigaVUE-TA200, GigaVUE-TA25 and GigaVUE-TA400) using the supplied screws.

As shown in [Figure 1 GigaVUE TA Series Traffic Aggregator Rack Ears in Front-Mount Position](#), the rack ears can be attached for a front-mount or rear-mount installation. Select the installation that best fits the needs. For example, one position may provide better clearance for rack doors at the front of the chassis.

2. While one person supports the weight of the unit with the rack ears flush to the chassis, a second person can attach the ears to the rack with the supplied screws.

Four-Post Rack Methods:

GigaVUE TA Series Traffic Aggregation nodes also come with a pair of full length mounting rails. These rails can be used for four point mounting on four-post racks. The keyhole rivets on the sides of each node can be used to adjust the fit of the node to the desired position or dimension on the rack.

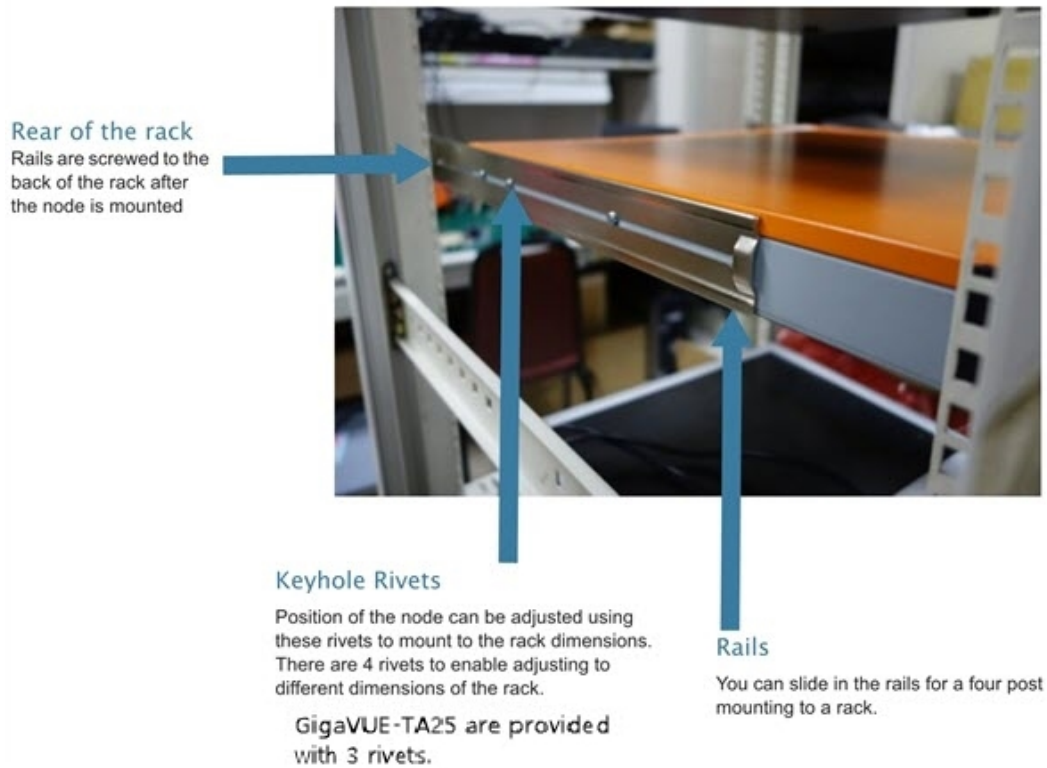

Figure 2 GigaVUE TA Series Traffic Aggregator with Rail Mounting for Four-Post Racks

To mount the GigaVUE TA Series Traffic Aggregation node in a four-post rack:

1. Attach the orange rack ears to the front of the unit using the supplied screws.



Figure 3 Front View of the Mounted Node to the Four-Post Rack

2. Slide in the provided rails on to the node. The position of the rails can be adjusted to fit the dimensions of the rack by sliding over the rivets and placing them securely over the rivets once set in the desired position.



Figure 4 Rear View of the Mounted Node and Rails on the Four-Post Rack

3. Last, tighten the rails to the rear posts using the supplied screws.

Basic Connections and Configuration

This chapter describes how to establish your first configuration session with the GigaVUE TA Series Traffic Aggregator and set the basic initial configuration options necessary to get you up and running.

Refer to the following sections for details:

Grounding the GigaVUE TA Series Chassis



The GigaVUE TA Series chassis is drilled for ground screws at the rear of the chassis. Connect grounding wire with spade lugs to the ground screws on the chassis and earth ground using the following procedure.

1. Locate the grounding holes at the rear of the chassis. Refer to [Grounding the GigaVUE TA Series Chassis](#) or [Figure 6 Ground Screws \(GigaVUE TA Series-Shown\)](#).



Figure 5 Ground Screws (GigaVUE TA Series Shown)



Figure 6 Ground Screws (GigaVUE TA Series-Shown)

2. Install ground screws meeting the following specifications:
#8 Panhead, Phillips-drive, Exterior SEM screw Thread size = 32Length = 1/2in (1.27cm)
3. Connect grounding wire with spade lugs both to the ground screws and to earth ground. The specifications for the ground wire and lugs are as follows:
Standard Wire 14 (AWG); Stud Size #6 (0.138in/0.351cm); Spade Width 0.32in/0.813cm
4. Tighten the screws to secure both the chassis ground screws and the earth ground screws.

Avoid Electrostatic Damage!

IMPORTANT: Always take precautions to avoid electrostatic damage:

- Always use an ESD-preventive wrist or ankle strap and ensure that it makes good skin contact. The strap can be connected to one of the following:
 - Captive installation screws on chassis.
 - Any unpainted surface on the chassis.
- Avoid contact between the cards and clothing. The wrist strap protects only the chassis from ESD voltages on the body. ESD voltages on clothing can still cause damage.

Connecting Power to the GigaVUE[®] TA Series

The procedure below describes how to supply power to the GigaVUE-TA400 node.

1. Plug an approved C13 power cable (C15 power cable for GigaVUE-TA400) into each of the power supplies at the rear of the GigaVUE-TA400 as shown in [Figure 7 Connecting AC Power to Figure 9 Connecting AC Power on a GigaVUE TA Series-TA200](#).

NOTE: For information on connecting the optional DC power supplies, Refer to [Connecting -48V DC Power Supplies](#).



Figure 7 Connecting AC Power



Figure 8 Connecting AC Power on a GigaVUE TA Series-TA100



Figure 9 Connecting AC Power on a GigaVUE TA Series-TA200

2. Plug the other end of the power cable(s) into a power source that can supply adequate power.

NOTE: If you are using the optional second power supply provided with the node, plug the two power supplies into separate circuits for optimal power protection. For information on the GigaVUE TA Series power requirements, refer to [Power Requirements](#).

NOTE: To avoid disk corruption, please ensure the "reload halt" command is executed before an ungraceful power shutdown or power supply module removal.

NOTE: The GigaVUE TA Series does not have power switches – once you connect the system to power, it automatically powers on.

3. Power is turned ON when the unit is plugged in, and turned off when the unit is unplugged.
4. Once the power supply is turned OFF, wait for 1 minute (60 seconds) before turning the power supply ON for GigaVUE TA Series

Refer to [Connecting Serial Console and Mgmt Ports](#) for information on how to connect to the GigaVUE TA Series command-line interface (CLI).

Connecting -48V DC Power Supplies

The GigaVUE TA Series Traffic Aggregator is available with two DC power supplies instead of the standard AC power supply. This section provides instructions for connecting a -48V DC power source to the DC power supplies.

To connect a -48V DC input to the DC power supply:

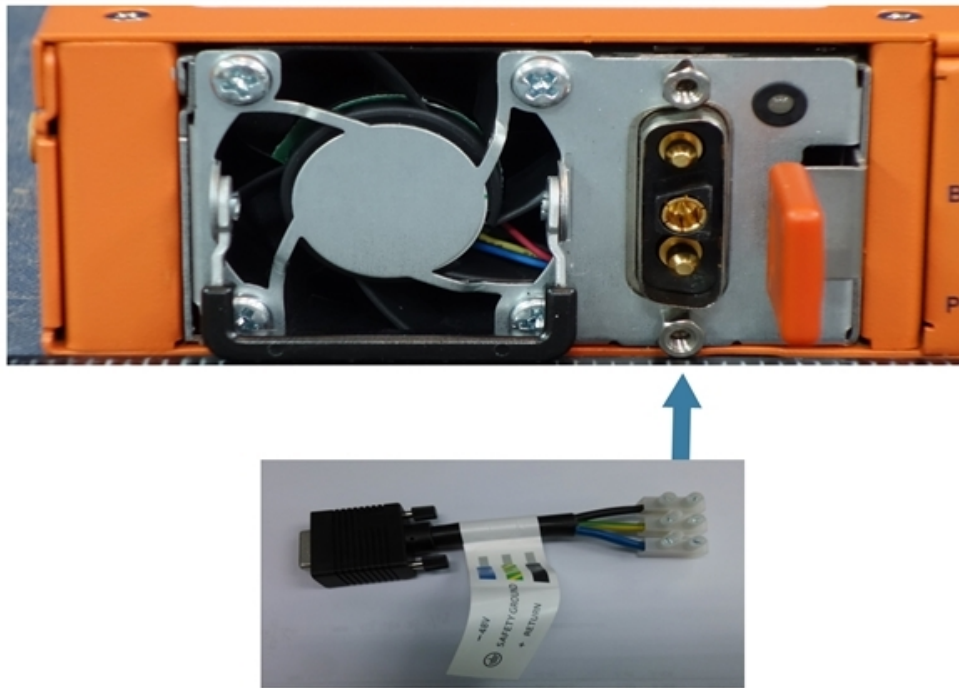

Figure 10 Connecting -48V DC Power Cable Adapter

1. Plug the DC power cable adapter into the DC power supply. For screw terminal DC power supply, use ring terminal. This is not applicable for GigaVUE-TA400.

NOTE: Terminal block supports 10AWG.

2. If PSM grounding is required, connect earth ground to the SAFETY GROUND (green/yellow) terminal using a straight blade screwdriver.
3. Connect the positive and negative power wires to the appropriate terminals using a straight blade screwdriver.
 - o Connect the positive source wire to the + RETURN (black) terminal using a straight blade screwdriver.
 - o Connect the -48V source wire to the -48V (blue) terminal using a straight blade screwdriver.

IMPORTANT: The leads to the DC power supply modules on the GigaVUE TA Series node should attach from the side of the chassis **away** from the terminal block. Run the wires to avoid obstructing airflow for the adjacent fans.

4. Repeat Step 1 through Step 3 for the other power supply modules.

Cautions for Power and Ground connections

Caution : Class I Equipment.

The GigaVUE TA Series equipment must be earthed. The power plug must be connected to a properly wired earth ground socket outlet. An improperly wired socket outlet could place hazardous voltages on accessible metal parts.

Caution: GigaVUE-TA400.

The -48 to -60 VDC hot-plug power supply is not intended for direct connection to the DC supply branch circuit. It only connects this power supply to a certified DC source that provides an independent over current-protected output for each DC power supply. Each output over current-protected device in the PDU must be suitable for interrupting fault current available from the DC power source and must be rated no more than 40A.

It must connect the power supply ground screw located on the front of the power supply to a suitable ground (earth) terminal: 8 AWG. This terminal must be connected to a suitable building ground (earth) terminal. **Do Not** rely on the rack or cabinet chassis to provide adequate ground (earth) continuity.

This product is intended to be installed in restricted access area. It should be accessible to skilled and instructed persons with proper authorization. Access should be controlled by using a lock or tool and key, or other means of security, and should be controlled by the authority responsible for the location. Access can only be gained by service persons or by users who have been instructed the reasons for the restrictions applied to the location and have been instructed any precautions that shall be taken. **NEVER** open the equipment and/or switch the plug-in power supplies and fan tray modules. For safety reasons, the equipment should only be opened and maintained by qualified service persons/ skill persons.

CAUTION: TO COMPLETELY REMOVE POWER FROM THE UNIT IN ORDER TO AVOID

"SHOCK HAZARD", FIRST TURN OFF POWER AND REMOVE POWER CABLES.



Caution: The insulation of the protective earthing conductor shall be green-and-yellow.

Caution: When installing DC Power to GigaVUE-TA400, a Skilled Person is needed to connect the Power.

Cable Suggestion to use VW-1, 600V, 105 degree C, tightening torque : 13.88/1.57 (lb-in/N.m), Wire Range : 8-18AWG, Wire Type: CU's power cable(wire).

Caution : The output of certified DC source must be grounded.

Précautions relatives au raccordement à l'alimentation et à la terre

Attention:Équipement de Classe I.

L'équipement GigaVUE série TA doit être mis à la terre. La fiche électrique doit être branchée à une prise de courant correctement raccordée à la terre.

Une prise de courant dont le câblage est incorrect pourrait causer la présence de tensions dangereuses sur les éléments métalliques accessibles.

Attention :GigaVUE-TA400

L'alimentation électrique 48 à 60 V CC enfichable à chaud n'est pas destinée au raccordement direct au circuit de dérivation d'alimentation CC. Elle raccorde uniquement cette alimentation électrique à une source CC certifiée qui fournit une sortie indépendante protégée contre les surintensités à chaque alimentation électrique CC. Chaque dispositif de sortie protégé contre les surintensités de l'unité d'alimentation électrique doit pouvoir interrompre un courant de défaut provenant de la source d'alimentation CC et doit présenter une intensité nominale maximale de 40 A. Il doit raccorder la vis de mise à la terre de l'alimentation électrique, située à l'avant de l'alimentation électrique, à une borne de terre (masse) appropriée : 8 AWG. Cette borne doit être raccordée à une borne de terre (masse) appropriée du bâtiment. N'utilisez pas le châssis du rack ou de l'armoire pour assurer une continuité de mise à la terre (masse) adéquate. Ce produit est destiné à être installé uniquement dans une zone à accès restreint. Il n'est accessible qu'aux personnes qualifiées et formées disposant d'une autorisation appropriée. L'accès est sécurisé au moyen d'une serrure ou d'un outil et d'une clé, ou de tout autre moyen de sécurité, et contrôlé par l'autorité responsable du site. L'accès n'est autorisé qu'au personnel de service ou aux utilisateurs qui ont été formés aux raisons des restrictions appliquées à l'emplacement et aux précautions qui doivent être prises. N'ouvrez jamais l'équipement et/ou ne commutiez jamais les alimentations électriques enfichables et les modules de plateaux de ventilateurs. Pour des raisons de sécurité, l'équipement ne doit être ouvert et maintenu que par des personnes formées/du personnel de service qualifié.

Attention : POUR RETIRER COMPLÈTEMENT L'ALIMENTATION DE L'APPAREIL AFIN D'ÉVITER UN « RISQUE DE DÉCHARGE », COUPEZ D'ABORD L'ALIMENTATION, PUIS RETIREZ LES CÂBLES ÉLECTRIQUES



Attention : L'isolement du conducteur de terre de protection doit être vert et jaune.

Attention : lors de l'installation de l'alimentation CC sur GigaVUE-TA400, une personne qualifiée est nécessaire pour connecter l'alimentation Câble; suggestion d'utiliser VW-1, 600V, 105 degrés C, couple de serrage : 13.88/1.57 (lb-in/N.m), gamme de fils : 8-18 AWG, type de fil : câble d'alimentation de CU (fil).

Attention : La sortie de la source DC certifiée doit être mise à la terre

Warning: Fiber Optic Port Safety

GigaVUE TA Series nodes are intended to be installed in an UL certified Optical Transceiver Module, Laser Class 1. When using a fiber optic port, never look at the transmit laser while it is powered on. Also, never look directly at the fiber port and fiber cable ends when they are powered on. If need further assistance, please contact [Gigamon Technical Support](#) for further information.

Avertissement : Sécurité du port fibre optique

Les nœuds GigaVUE série TA sont destinés à être installés dans un module émetteur-récepteur optique certifié UL, classe de laser 1. En cas d'utilisation d'un port fibre optique, ne regardez jamais le laser émis pendant qu'il est sous tension. De même, ne regardez jamais directement le port fibre et les extrémités des câbles en fibre lorsqu'ils sont sous tension. Pour tout besoin d'aide supplémentaire, veuillez contacter [Gigamon Technical Support](#) afin d'obtenir de plus amples informations.

Replacing Fans

Fans are field-replaceable. If a fan fails, you can replace it. Identify the fan that failed, and replace it with a working fan using the procedures in this section.

To remove a fan:

1. Locate lever and handle as shown in [Figure 11 Replacing a Fan \(GigaVUE TA Series-TA400 Shown\)](#).

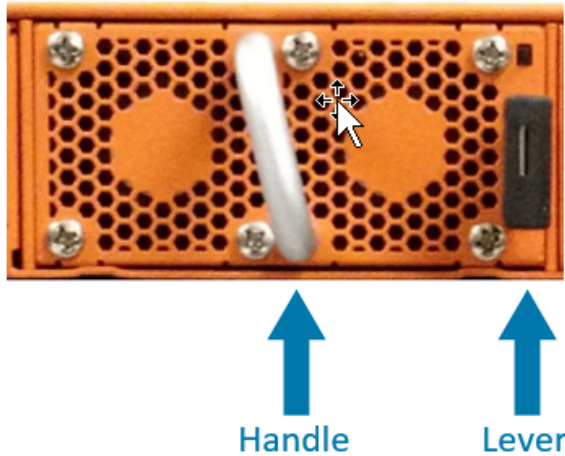

Figure 11 Replacing a Fan (GigaVUE TA Series-TA400 Shown)

2. Push lever towards handle.
3. Pull on handle to remove the fan from the slot.

To insert a fan:

1. Place fan in empty slot.
2. Use handle to slide fan into slot.
3. When fan is fully inserted, it locks in place.

Connecting Serial Console and Mgmt Ports

To make basic connections (serial console and Mgmt ports):

1. Locate the DB9-to-RJ45 serial cable provided with the GigaVUE TA Series-TA400 node. This cable is called a *console cable*.

NOTE: This cable is Cisco-compatible. Refer to [B Console Port Signaling and Cabling](#) for pinout details.

2. Connect the RJ45 end of the console cable to the **console** port.

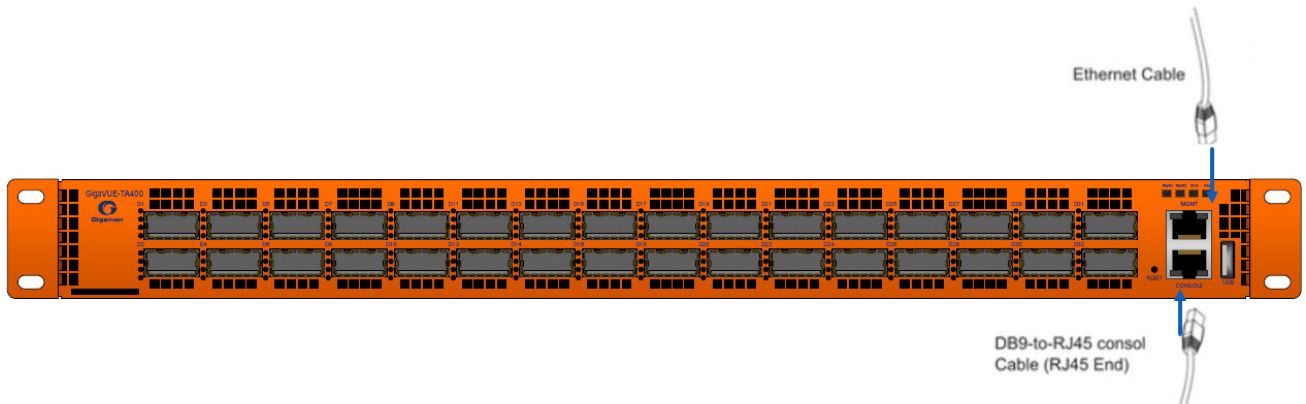

Figure 12 *Connecting the Console and Management Ports*

3. Connect the DB9 end of the console cable to a PC's COM port.
4. Connect a standard Ethernet cable (Cat5 or better) to the 10M/100M/1000M **Mgmt** port.
5. Connect the other end of the Ethernet cable to an Ethernet network.

Configuring Basic Settings

This section describes how to perform the initial configuration of basic settings over a serial terminal connection to the console port.

The system administrator must initially log in with a default **admin** account using a default password, and then must immediately change the password through the **jump-start** script. Refer to [Access the Command-Line Interface over the console Port](#).

Once you have used the console port to configure the Mgmt port's network properties, you can configure the GigaVUE TA Series node remotely using the Mgmt port's network connection.

NOTE: The same commands are available in the command-line interface regardless of how you connect.

Access the Command-Line Interface over the console Port

1. Make the basic power and console cable connections described in [Connecting Serial Console and Mgmt Ports](#) and power on the GigaVUE TA Series node.
2. Start a terminal application on the PC. Common terminal applications include TeraTerm, PuTTY, and Hyperterminal.
3. Select the COM port connected to the console cable attached to the console port. For example, **COM1**.
4. Configure the port settings for the console connection as follows:
 - o **Bits per second** – 115,200

- o **Data bits** – 8
- o **Parity** – None
- o **Stop bits** – 1
- o **Flow control** – None

NOTE: The GigaVUE-TA100, GigaVUE-TA200, GigaVUE-TA200E, GigaVUE-TA400, and GigaVUE-TA25 support only a fixed serial baud rate of 115,200bps.

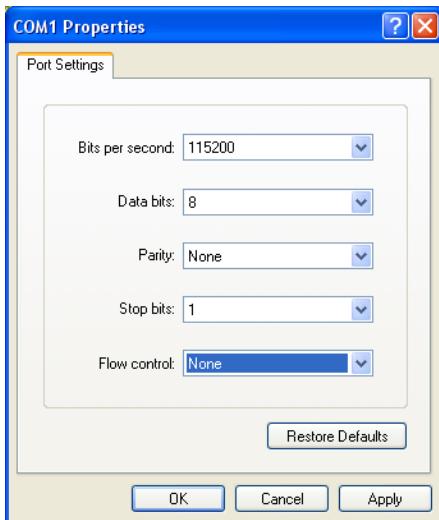

Figure 13 Setting COM Port Properties for the Console Connection

5. Start the terminal connection. You may need to press **Enter** a few times before you see the **login:** prompt.
6. Log in to the command-line interface with the following default user account and password:

User:admin

Password:admin123A!

The **configuration jump-start** automatically starts and forces a password change. The system administrator must change the password on the default **admin** account through the **jump-start** script. The default password (admin123A!) is no longer allowed. Refer to [Run the Jump-Start Script](#) for details.

A password must meet the following standards:

- include 8-30 characters
- include at least one numeral
- include at least one upper case letter
- include at least one lower case letter
- include at least one special character (for example, !, @, #, \$, %, ^, &, or * –, ASCII 0x21, 0x2F, 0x3A, 0x40, 0x5B, 0x5F, 0x7B, 0x7E)
- Must not include the user name or parts of full-name.

At the Admin password? prompt in the **jump-start** script, enter a new password that meets the standards, then confirm the password.

Run the Jump-Start Script

Gigamon provides the GigaVUE TA Series nodes with a **jump-start** script that walks you through the process of configuring basic settings. Run this script as follows:

1. Switch to **Config** mode.

There are three command entry modes, each with increasingly powerful rights – **Standard**, **Enable**, and **Config**. The jump-start script is only available in config mode:

- a. Type **en <Enter>** to switch to Enable mode.

The system prompt changes from **[hostname] >** to **[hostname] #**.

- b. Type **config t <Enter>** to switch to Config mode.

The system prompt changes from **[hostname] #** to **[hostname] (config) #**.

2. Reset the terminal settings to match the current window with the following command:

terminal resize

3. Type **config jump-start** to run the jump-start script.
4. Follow the jump-start script's prompts to set each of the settings listed below.

NOTE: If you change your mind about a particular setting, you'll have a chance to change it at the end of the script.

Hostname	The hostname appears in the system prompt and is used to identify the chassis in SNMP traps.
Management Port Network Settings	Use either DHCP or specify a static IP address and netmask. If you do not use DHCP, you are prompted to configure the following additional options: <ul style="list-style-type: none"> • Default Gateway Supply the IP address of the default gateway for the node. • DNS Server Supply the IP address of the DNS server for the node. Note that a valid DNS server is required for successful use of TACACS+. • Domain Name Supply the domain name for the node (for example, mycompany.com).
Default Gateway	Supply the IP address of the default gateway for the system.
DNS Server	Supply the IP address of the DNS server for the system. Note that a valid DNS server is required for successful use of TACACS+.
Domain Name	Supply the domain name for the system (for example, mycompany.com).

Enable IPv6?	You can enable the use of IPv6 for the management port. IPv6 is used in addition to IPv4 if you enable this option. If you enable the IPv6 you have the option of enabling IPv6 autoconfiguration or specifying a static address.
Security Settings	<p>Enable the following security settings:</p> <ul style="list-style-type: none"> ■ secure cryptography mode ■ secure passwords mode ■ minimum password length <p>Refer to the GigaVUE-OS CLI Reference Guide for information on security.</p>
Admin Password	The password for the admin account must be changed to a non-default password.
Cluster Enable?	<p>Enable cluster support if this node will be a part of a cluster of connected GigaVUE TA Series nodes. If you enable cluster support, the jump-start script prompts you to supply the Cluster ID, Cluster Name, and Cluster Mgmt Virtual IP Address. You can join an existing cluster by supplying values that match existing settings.</p> <p>If clustering is enabled, you will not be prompted for a box ID in the next step.</p> <p>Refer to the <i>GigaVUE-OS CLI Reference Guide</i> for information on setting up a cluster.</p> <div style="border: 1px solid black; padding: 5px; margin-top: 10px;"> <p>NOTE: Connecting a Traffic Aggregator to a cluster requires a license.</p> </div>
Box ID for the Node	<p>Supply a numerical box ID for the node. This box ID is used to identify network/tool ports in the node – the format is box ID/ slot ID/port ID.</p> <p>You will be prompted for a box ID only if clustering was not enabled in the previous step.</p>

5. Review your settings. You can change a setting by specifying its listed line number and re-entering the setting.
6. When you are satisfied with your settings, exit the script as prompted. The system automatically saves your settings.
7. Restart the system with the **reload** command.

Need to Change Any Settings?

If you need to change any of the settings you made in the jump-start script, you can either run the script again or change individual settings using the following commands in the Configure command mode:

- Use the **hostname** command to change the system's hostname.

- Use the **interface eth0** command to reconfigure or fine-tune Mgmt port settings, including basic IP settings (DHCP or static address and subnet mask) and physical parameters (duplex, MTU, and speed).
- Use the **ip** command to change the default gateway, DNS server, and domain name.
- You can also use the **username admin password <password>** command to change the **admin** user's password. Refer to [Changing the admin Account Password](#).

Refer to [Completing the Initial Setup](#) for a quick summary of the available GigaVUE TA Series commands for TA Series nodes.

Advanced Features Licensing

GigaVUE-TA400 nodes can be clustered with GigaVUE TA Series and HC Series nodes. Clustering is enabled with an Advanced Features License. Contact your Sales representative for Advanced Features Licenses. Refer to [Contacting Sales](#).

Command-Line Basics

This section provides a quick orientation to the GigaVUE TA Series command-line interface – how to enter commands, how to get help, and so on.

Command-Line Modes

The GigaVUE-OS can operate in one of three modes, each with its own set of available commands – Standard, Enable, and Configure. When you first launch the CLI, you start in Standard mode with access to a limited amount of commands used to review system status. As you move from **Standard** mode to **Enable** mode to **Configure** mode, both the power and the number of commands available increase, as summarized in [Figure 14 GigaVUE-OS Command-Line Modes](#).

NOTE: If you are working simultaneously with multiple GigaVUE TA Series nodes, you may want to assign each a separate hostname so its easy to identify separate terminal sessions from the system prompt. Admin users can do this in Configure mode with the **hostname <name>** command.

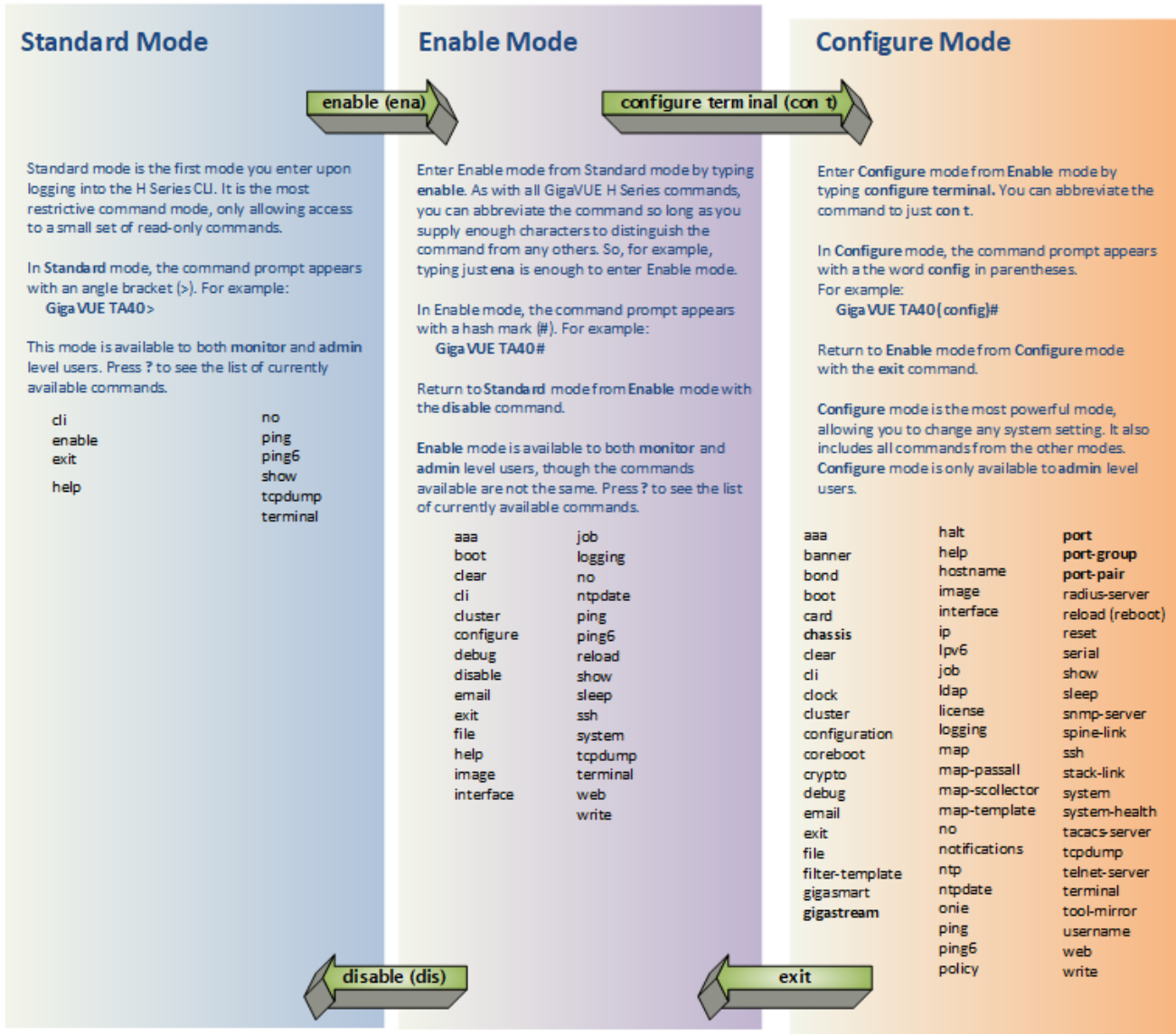

Figure 14 GigaVUE-OS Command-Line Modes

Entering Commands in the CLI

The GigaVUE TA Series CLI provides several conventions that make it easy to identify available commands and enter them quickly:

Technique	Description
Context-Sensitive Help	<p>The <code>?</code> symbol is the key to receiving help wherever you are in the CLI:</p> <ul style="list-style-type: none"> Type the <code>?</code> by itself to see a list of all available commands. Word Help – Type a partial word with a

Technique	Description
	<p>? mark immediately following the partially-typed word to see a list of all possible commands using the word entered so far.</p> <p>For example, if you typed i? in Configure mode, the CLI would return the following possible commands based on what you've entered so far:</p> <p>image interface ip</p> <ul style="list-style-type: none"> ▪ Command Help – Type a command followed by a question mark to see all possible arguments for the command as entered. If the system returns <cr>, that means the command can be entered as-is. <p>For example, if you entered gigastream ?, you would see alias. You can build your way through the entire command tree by entering ? after each new argument. For example, after entering gigastream alias myalias ?, you would see the next valid argument – port-list.</p> <p>NOTE: Typing ? accesses the help system immediately – you do not need to press <Enter>.</p>
<p>Partial Command Entry</p>	<p>For all GigaVUE TA Series commands and arguments, you only need to enter enough characters to distinguish the command from all other available commands. So, for example, you do not have to enter the full command username – there is only one command starting with the letter u, so you only have to enter u.</p>
<p>Command Completion</p>	<p>If you have partially typed a command, you can press Tab and the CLI will attempt to complete the command for you based on what's been entered so far.</p> <p>It is helpful to use the Command Completion feature together with partial command entry – you can press Tab while entering a command to see a list of all available commands matching what you've entered so far. For example, you can press p<Tab> and the system will return:</p> <p>pass-all ping port port-pair</p> <p>Based on this information, you know that you only need to enter the letter pa to uniquely identify what you've entered as pass-all.</p>

Command-Line Syntax – Entering Commands

You enter configuration commands for the GigaVUE TA Series node in the command-line interface by typing enough characters to uniquely identify the command and pressing **<Enter>**.

When entering commands, keep in mind the following rules:

- Successful commands return no response in the CLI; commands with errors return an error response beginning with **%**, followed by a short error description.
- All commands are case-sensitive and entered in lower case.
- Port numbers are entered in **<box ID>/<slot ID>/<port ID>** format. For the GigaVUE TA Series nodes, the chassis ID and slot number are always **1**.
- Strings must consist entirely of alphanumeric characters with no spaces. The only exceptions are the underscore (**_**), hyphen (**-**), exclamation point (**!**), “at” symbol (**@**), and period (**.**) characters. Those are allowed.

For example, in Config mode, **port 1/1/q12 alias My_Alias** is legal, but **port 1/1/q12 alias My Alias** is not.

NOTE: Some string fields do accept spaces provided the input is made inside quotation marks

Config Mode Syntax

When using the GigaVUE TA Series CLI, the “config” part of the command is implied whenever you are working in Configure mode. The system prompt helps you remember this by including the word **(config)** in parentheses. For example:

```
(config) #
```

So, instead of entering **config map** to connect a network port to a tool port, you just enter **map** followed by the necessary arguments. The **config** part is implied because you are already working in the Configure command mode. For example:

```
(config) # map alias myTA40map from 1/1/q1 to 1/1/q5
```

Paging through CLI Output

By default, the GigaVUE TA Series CLI returns output exceeding the configured terminal length in pages. The CLI provides the same features for working through the paged output as the Linux programs **less** and **more**. Press the **h** key to see paging options – [Figure 15 Viewing Paging Options](#) provides an example.

If you prefer, you can disable paging either for the current session or by default:

- **Disable for Current Session**
`(config) # no cli session paging enable`
- **Disable for All Sessions (Default)**
`(config) # no cli default paging enable`

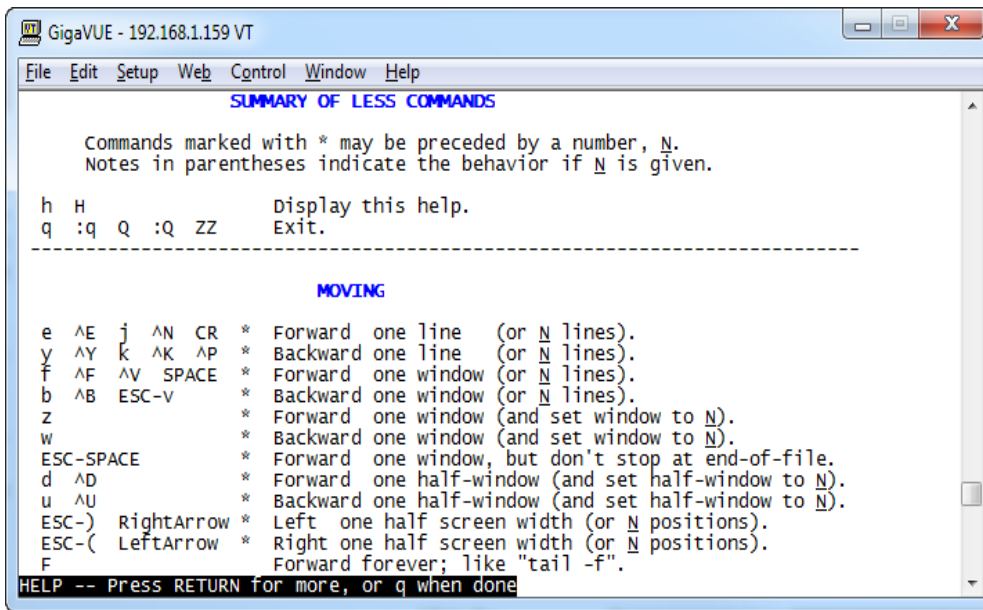

Figure 15 Viewing Paging Options

The Basic Commands

The following table lists each of the top level commands for the GigaVUE-OS CLI in Configure mode. Most commands have multiple supported arguments. You can see the exact arguments available at any point of command entry by typing it into the CLI followed by `?`.

Command	Description
aaa	Configure authentication, authorization, and accounting settings.
banner	Set a system login banner.
bond	Configure bonded interface settings.
boot	Configure system boot parameters.
card	Configure a card. On GigaVUE-TA400 nodes, use the card command to enable additional ports on GigaVUE-TA400 nodes.
chassis	Configure the chassis.
clear	Reset statistics or clear caches.
cli	Configure CLI shell options.
clock	Set the system clock or timezone.
cluster	Configure a cluster of connected nodes.
configuration	Manage configuration files.
configure	Enter Configure mode.
coreboot	Upgrades the BIOS image on GigaVUE-TA400.

Command	Description
<i>crypto</i>	Manage X.509 certificates for the node's Web server.
<i>debug</i>	Generate a dump file for use in debugging issues with Gigamon Technical Support.
<i>disable</i>	Leave Enable mode and return to Standard mode.
<i>email</i>	Configure email and event notification via email.
<i>enable</i>	Enter Enable mode.
<i>exit</i>	Leave Configure mode and return to Enable mode or log out of the CLI.
<i>file</i>	Manage TCP and debug dump files on disk.
<i>filter-template</i>	Configures flexible filter templates on GigaVUE-TA400.
<i>gigasmart</i>	Configures a stack port interface to provide Internet connectivity for a GigaSMART card or module.
<i>gigastream</i>	Configure a GigaStream – a group of ports acting as a single addressable tool port destination or stack-link.
<i>halt</i>	Shut down the system without powering it off.
<i>help</i>	View a description of the interactive help system.
<i>hostname</i>	Specify the system's hostname. The hostname appears in the system prompt and in SNMP traps.
<i>ib-pathway</i>	Reserved for future use.
<i>image</i>	Manage system software images.
<i>interface</i>	Configure network interfaces.
<i>ip</i>	Configure IP settings for the eth0 Mgmt port.
<i>ipv6</i>	Configure IPv6 settings for the eth0 Mgmt port.
<i>job</i>	Configure scheduled jobs.
<i>ldap</i>	Configure LDAP server settings for authentication.
<i>license</i>	Activate features using license keys.
<i>logging</i>	Configure event logging.
<i>map</i>	Configure maps and map rules to manage GigaVUE TA Series traffic distribution.
<i>map-passall</i>	Create a pass-all map to send all traffic on a network port to a tool port irrespective of the other packet distribution in place on the port.
<i>map-scollector</i>	Configure shared collector map parameters.
<i>map-template</i>	Create a map template.
<i>no</i>	Delete or clear certain configuration options.
<i>notifications</i>	Configures notification settings.
<i>ntp</i>	Enable and disable the use of NTP, as well as add NTP servers.
<i>ntpdate</i>	Set system clock once from a remote server using NTP.
<i>ping</i>	Send ICMP echo requests to a specified host.
<i>ping6</i>	Send ICMPv6 echo requests to a specified host.
<i>policy</i>	Configures an active visibility policy.
<i>port</i>	Configure port type, parameters, and filters.

Command	Description
<i>port-group</i>	Create a group of ports.
<i>port-pair</i>	Configure a port-pair on a pair of network ports within the same node. A port-pair is a bidirectional connection in which traffic arriving on one port in the pair is transmitted out the other (and vice-versa) as a passthrough TAP.
<i>radius-server</i>	Configure RADIUS server settings for authentication.
<i>reload(reboot)</i>	Reboot or shut down the node.
<i>reset</i>	Reset specified portions of the system configuration to their factory states.
<i>serial</i>	Set options for the serial console port.
<i>sfp</i>	Reserved for future use.
<i>show</i>	Display configuration and status information for a wide variety of settings and entities.
<i>sleep</i>	Sleep for a specified number of seconds.
<i>snmp-server</i>	Configure SNMP settings, including the local SNMP server, notification events, and notification destinations.
<i>spine-link</i>	Configures spine links in a cluster with a leaf and spine architecture.
<i>ssh</i>	Enable and disable SSH access, as well as manage settings.
<i>stack-link</i>	Configure a stack-link between two nodes in a cluster. Stack-links are used to carry data traffic between nodes in a cluster.
<i>system</i>	Change system settings.
<i>system-health</i>	Configures system health behaviors.
<i>tacacs-server</i>	Configure TACACS+ server settings for authentication.
<i>tcpdump</i>	Display packets from any eth0 port in the node on a network.
<i>terminal</i>	Set terminal parameters, including width and length.
<i>tool-mirror</i>	Configures a tool-mirror connection between two tool ports. A tool-mirror connection sends all packets arriving on one tool port to a second tool port on the same node.
<i>traceroute</i>	Trace the route packets take to a destination.
<i>tunnel</i>	Reserved for future use.
<i>uboot</i>	Installs new uboot software.
<i>username</i>	Manage user accounts.
<i>web</i>	Configure the Web server used for GigaVUE-FM GUI support on the node.
<i>write</i>	Save the running configuration to persistent storage.

Completing the Initial Setup

At this point, you have logged in to the command-line interface using the **admin** account, configured the **Mgmt** port's network properties for SSH access, and have explored the command-line interface.

There are a few more steps you should perform to complete the initial configuration before you set up network ports, tool ports, and aggregate traffic. These tasks include:

- Switch to the Configure mode. Refer to [Enter the Configure Command-Line Mode](#).
- Configure SSH access to the node. Refer to [SSH2](#).

- Configure some basic user accounts. Refer to [Initial User Account Configuration](#).
- Configure the node name. Refer to [Configuring the GigaVUE TA Series Host Name](#).
- Configure time and date options for the node. Refer to [Configuring GigaVUE TA Series Node's Time Options](#).
- Configuring Internet Explorer for Use with GigaVUE-FM. Refer to [Configuring Internet Explorer for Use with GigaVUE-FM](#).
- Save your changes! Refer to [Saving Changes](#).

Enter the Configure Command-Line Mode

Keep in mind that the GigaVUE-OS have three different command modes for the CLI – **Standard**, **Enable**, and **Configure**. The commands described in the sections below are all only available in Configure mode. Switch to configure mode as follows:

Command	Notes
> enable	You only need to supply enough of each command to positively identify it among the other available commands. So, in this example, you could just type ena and press Enter.
# configure terminal	Similarly, this command can be entered as con t .
(config) #	Notice how the system prompt changes with each command mode. Command modes offer greater control over the box as you ascend from Standard to Enable to Configure .

SSH2

SSH2 is available for remote connections to the GigaVUE TA Series Traffic Aggregator's **Mgmt** port. By default, SSH2 is enabled. Use the **ssh** commands in Configure mode to enable or disable the corresponding connections. To disable the corresponding connection, you include **no** before the command, as demonstrated in the table below. For example:

Command	Notes
Enable: (config) # ssh server enable Disable: (config) # no ssh server enable	When SSH2 is enabled, you can use any compliant SSH2 client to connect to the command-line interface remotely. For example, to connect using the SSH2 client, PuTTY: <ol style="list-style-type: none"> Start PuTTY and enter the GigaVUE TA Series Traffic Aggregator's IP address in the Host Name field. Click the SSH protocol radio button. Click Open to open a connection. If this is your first connection PuTTY warns you that the host key presented by the GigaVUE TA Series node is not in your cache. You can add the key, connect without adding the key, or cancel the connection. Refer to Verifying Host Keys During Connection for information on how to verify that the host key shown is the correct one. Log in with GigaVUE TA Series credentials.

Advantages of SSH2

SSH2 is a secure choice for remote connections, providing an encrypted channel instead of relying on clear text. It also provides stronger user authentication capabilities, including the use of a public **host key**. Host keys uniquely identify a server, helping guarantee that the server you're connecting to is the server you think it is. The GigaVUE TA Series nodes also include default RSA v1/v2 and DSAv2-encrypted public host keys (SSH2 supports both RSA and DSA encryption algorithms). The first time you connect to the GigaVUE TA Series node with an SSH2 client, the client will warn you that the host keys are not in your local cache and show you the actual host key presented by the node. Your client will most likely give you the option of trusting the key, adding it to your local cache. Once you've trusted the key, your client will alert you during connection if a different key is presented.

IMPORTANT: Telnet server functionality is no longer supported as of GigaVUE-OS 5.7.00.

Verifying Host Keys During Connection

To verify that the host key presented during an SSH2 connection is in fact the GigaVUE TA Series node's, you can connect over the console port (refer to [Access the Command-Line Interface over the console Port](#)) and use the **show ssh server host-keys** command to see the current public host keys and fingerprints for the GigaVUE TA Series node. Paste these in a file and keep them nearby when you connect via SSH2 the first time. This way, you'll be able to compare the actual host key to what your SSH2 client says is being presented. Once you've verified that they are the same, you can choose to trust the host key, allowing future connections to take place seamlessly.

Changing Host Keys

You can use the **ssh server host-key generate** command to change the default host keys provided with the GigaVUE TA Series node. The command has the following syntax:

```
ssh server host-key <rsa1 | rsa2 | dsa2> <private-key | public-key> generate
```

For example, to configure a new RSAv1 public hostkey, you could use the following command:

```
(config) # ssh server host-key rsa1 public-key generate
```

Initial User Account Configuration

Before you start mapping traffic, you must change the password for the **admin** account and add a few other accounts for use by different level users. (You may have already used the jump-start script to change the password for the **admin** account.)

Changing the admin Account Password

1. To change the password for the **admin** account using the **username** command, refer to the following:

```
(config) # username admin password <password>
```

Passwords must meet the following standards:

- o Include 8-30 characters.
- o Include at least one numeral
- o Include at least one capital letter
- o Include at least one special character (for example, **!**, **@**, **#**, **\$**, **%**, **^**, **&**, or ***** – ASCII [0x21, 0x2F], [0x3A, 0x40], [0x5B, 0x5F], [0x7B,0x7E]).

Enter a new password that meets the standards and confirm the password.

Setting Up Some Basic Accounts

1. The TA Series node has a local account database that can optionally integrate with an LDAP, RADIUS, or TACACS+ server for authentication. Any account you want to authenticate using an external AAA server must have a matching account name in the local database.

Authentication, user levels, and roles are discussed in detail in the *GigaVUE-OS CLI Reference Guide*. For now, however, it is easiest to simply create a few basic user accounts with different privilege levels. In general, user privileges are as follows:

- o Admin users have access to all command modes, including Standard, Enable, and Configure. They also have full permissions for all network, tool, and stack ports.
- o Operator users have access to all command modes, including Standard, Enable, and Configure. However, they only have access to the network and tool ports associated with their user group. New users are created with the operator role by default. You can add additional roles with the **username <username> roles add <roles>** command.
- o Monitor users have access to the Standard and Enable command modes. They cannot configure packet distribution (or any other global GigaVUE TA Series node options), but they can use the show command to review many of the settings in place on the node.

The following username commands create a new admin user and a new operator user:

Command	Comments
<pre>(config) # username psandoval password Nine9.Eight8! (config) # username psandoval roles add admin</pre>	Creates a new account named psandoval with a password and grants it admin privileges.
<pre>(config) # username bcrawford password Seven7.Six6!</pre>	Creates a new account named bcrawford with a password. New users are automatically created with default operator level privileges, so there is no need to grant an additional role.

- Once you have configured these basic user accounts, use the **show usernames** command to review your settings. [Figure 16 Reviewing the User List](#) shows some sample **show usernames** output after several users have been added.

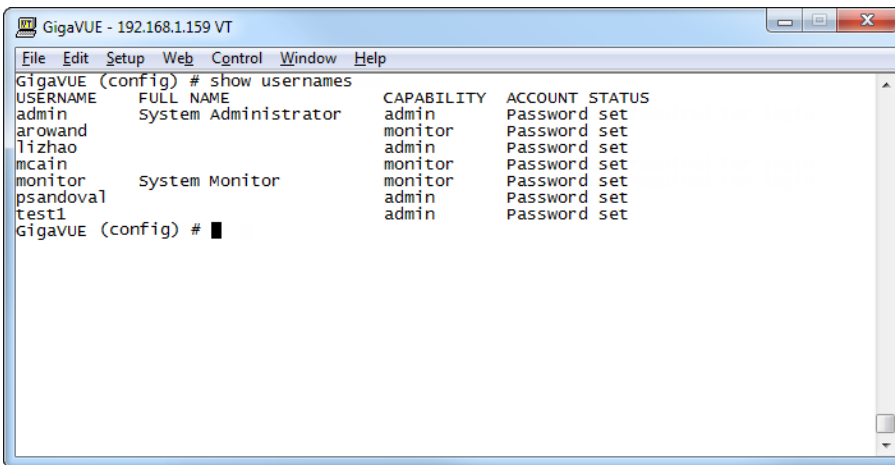

Figure 16 Reviewing the User List

Configuring the GigaVUE TA Series Host Name

It is generally a good idea to configure the GigaVUE TA Series node’s name, date, and time as part of your initial configuration. The following command shows how to set the system name. Refer to [Configuring GigaVUE TA Series Node’s Time Options](#) for information on setting options related to time and date.

Setting the System Name

- Use the **hostname** command to specify the system name. For example:

```
(config) # hostname GigaVUE TA Series-Customer
```

Configuring GigaVUE TA Series Node’s Time Options

The GigaVUE TA Series nodes include a variety of features for setting the time, including:

Method	CLI Command	For more information:
System Clock	<code>clock set hh:mm:ss yyyy/mm/dd</code>	Setting Time Manually
One-Time NTP Synchronization	<code>ntpdate <ntpserver address></code>	Performing One-Time NTP Server Synchronization
Persistent NTP Synchronization	Add server using <code>ntp server</code> command. Enable use of ntp with <code>ntp enable</code> command.	Using NTP Time Server for System Clock Synchronization

Setting Time Manually

The easiest way to set the GigaVUE TA Series node's time is manually with the **clock set** command. For example:

```
(config) # clock set 05:18:38 2011/05/24
```

NOTE: Even if you are using NTP/SNTP, it is a good idea to configure time manually as well. The GigaVUE TA Series node will automatically fall back to the manual time setting if it is unable to synchronize with the specified time server.

The **show ntp** will show the current state of the NTP server in use; the **show clock** command shows the current GigaVUE TA Series node's time.

Performing One-Time NTP Server Synchronization

You can perform a one-time synchronization with an NTP server using the **ntpdate** command. For example:

```
(config) # ntpdate time.nist.gov
```

Note that this method does not provide updates to correct clock drift over time. It is generally preferable to use persistent NTP synchronization with the **ntp** commands.

Using NTP Time Server for System Clock Synchronization

The GigaVUE TA Series nodes can optionally use one or more NTP servers for its time setting. Use the following procedure to add an NTP server to the GigaVUE TA Series node's list and enable the use of NTP.

1. Specify the address of the time server. For example, if the time server is on 192.168.1.10, you would use the following command:

```
(config) # ntp server 192.168.1.10
```

NOTE: There are many public NTP servers available on the Internet.

2. Turn on NTP with the following command:

```
(config) # ntp enable
```

3. The GigaVUE TA Series node connects to the specified NTP server and synchronizes to its time.

4. NTP reports times in UTC. Because of this, It is a good idea to specify the GigaVUE TA Series node's timezone so that UTC can be converted to the local timezone.

You specify the timezone in terms of the offset from UTC (either plus or minus). For example, to set the timezone for a GigaVUE TA Series node in the United States for Pacific Standard Timezone, you would use the following command:

(config) # clock timezone America North United_States Pacific

Once you've finished configuring NTP options, use the **show ntp** command to check the status of clock synchronization (Figure 17 Checking NTP Status and Configuration).

```
GigavUE (config) # show ntp
NTP is enabled.
Clock is synchronized. Reference: 69.25.96.13. offset: -4.846 ms.
Active servers and peers:
-----
Address      Status      Stratum  offset  Ref  Poll  Last
(msec)      Clock      (msec)  Clock   Int  Resp
              (sec)
-----
69.25.96.13  sys.peer (*)  1        -4.846  .ACTS.  64    24
GigavUE (config) #
```

Figure 17 Checking NTP Status and Configuration

Configuring Internet Explorer for Use with GigaVUE-FM

GigaVUE-FM works best in Internet Explorer when the browser is configured to check for newer versions of stored pages every time pages are visited. Enable this option as follows:

1. Open Internet Explorer.
2. Select the **Tools > Internet Options** command.
3. In the **General** tab, locate the **Browsing history** section and click its **Settings** button.
4. Set the **Check for newer version of stored pages:** option to **Every time I visit the webpage.**
5. Click **OK** on the Temporary Internet Files and History Settings dialog.
6. Click **OK** on the Internet Options dialog.

Configuring Automatic Email Notifications

The GigaVUE TA Series nodes provide powerful email notification capabilities, automatically sending emails to specified addresses when any of a wide variety of events take place on the system. Gigamon strongly recommends that you configure this feature so you have immediate visibility of events affecting system health.

You configure automatic email notifications with the **email** command and its arguments. Start by making sure the CLI is in Configure mode. If the **(config)** entry appears in the

system prompt, you are in Configure mode. If not, use the **enable** and **configure terminal** commands sequentially to change to Configure mode. Then, configure email notifications as follows:

Description	Command
<p>First, use the email mailhub command to specify the mail server to use for notification emails. In this example, the email server named smtp.emailsrvr.com is used. IP address can be used instead of a hostname.</p>	<pre>(config) # email mailhub smtp.emailsrvr.com</pre>
<p>Next, use the email auth command to supply the email account username and password. In this example, alerts@mycompany.com is shown with a password of mypassword123.</p>	<pre>(config) # email auth username alerts@mycompany.com (config) # email auth password mypassword123</pre>
<p>Once account is setup turn on email authentication.</p>	<pre>(config) # email auth enable</pre>
<p>Now that the settings are configured, let the system send emails. Set up who to send them to and when to send them. Use email notify recipient to configure the destinations for event notification emails. Multiple destinations can be specified by separating by commas with no spaces.</p>	<pre>(config) # email notify recipient cday@mycompany.com,mfelton@mycompany.com</pre>
<p>The email notify event command lets you configure which events will trigger automatic emails. There are quite a few events available – start by entering email notify event ? to see the list of available events. You can either enable individual events, or, use the all argument to enable them all.</p>	<pre>(config) # email notify event all</pre>

Description	Command
<p>It is a good idea to check your settings and make sure emails are sent successfully. You can do that with the email send-test command. If you do not receive the email, check the show log output to make sure the email was sent. Then, reconfigure email settings, if necessary.</p>	<p>(config) # email send-test</p>
<p>You may also want to configure and enable autosupport emails. Autosupport emails are sent directly to Gigamon’s Technical Support department when specified events take place, enabling proactive problem resolution. The GigaVUE TA Series is preconfigured with the correct destination address – you just need to enable the feature with the following command. Use show email events to see the list of events for which autosupport emails will be sent. You can change the list with the (no) email autosupport event command.</p>	<p>(config) email autosupport enable</p>
<p>That’s it! Emails will now be sent automatically to the configured addresses when any of the selected events take place.</p> <p>There are many other options for fine-tuning automatic email settings, including how to handle “dead letters” (emails that did not reach their recipient), how the email address of the GigaVUE TA Series should appear, the port for the email server, the reply-to address, and so on.</p>	

Using a Custom Banner

The GigaVUE TA Series nodes can display a customizable text banner at system startup before a user logs in. This way, users connecting to the system see the banner before they log in, giving them an idea of which system they are logging in to. The banner also appears after a user logs out.

Use the **banner login “<string>”** command to configure the login banner. For example:

(config) # banner login "Pacific Call Center"

NOTE: You only need to use quotation marks for the <string> if it includes spaces.

The next time you log in or out of the GigaVUE TA Series node, you will see the customizable banner.

Saving Changes

It is a good idea to get into the habit of using the **write memory** command to save changes as you make them. Later on, when you start setting up packet distribution, your changes will be added to the active configuration right away but would not be saved across a system reboot unless you use the **write memory** command to save your changes to flash.

NOTE: The name of the factory-provided configuration file is **initial**. You can refer to the name of the most recently booted configuration file by using the **show running-configuration** command (or **show configuration**) and look for the **## Running database** entry.

Connecting Ports on GigaVUE[®] TA Series

This chapter provides information on the transceivers supported for use with the GigaVUE TA Series.

Refer to the following sections for details:

Transceiver—Rules and Notes

Keep in mind the following rules and notes when you connect and use GigaVUE TA Series nodes with transceivers:

- Always use transceivers purchased from Gigamon to ensure interoperability and performance. Gigamon does not support transceivers purchased from other vendors.
- After removing an optical transceiver, the best practice is to wait seventeen (17) or more seconds before re-inserting the same or different optical transceiver. This includes the intervals between removal/insertion/re-insertion.
- Use the **show port params all** command to see transceiver type information for each of the network/tool ports in the GigaVUE TA Series nodes. Check the value of the **SFP type** field for the ports in question.
- Following are the nomenclatures for the GigaVUE TA Series node port numbers:

- Port numbers starting with a c (for example, c1) are 100Gb. They can also support 40Gb depending on the transceiver installed.
- Port numbers starting with a q (for example, q1) are 40Gb.
- Port numbers starting with an x (for example, x10) are 10Gb or 1Gb or 25Gb depending on the transceiver installed. They can also support 25 Gb on select platforms.

NOTE: The 40Gb QSFP+ SR Full Duplex (RX/TX) transceiver is not supported in conjunction with a TAP.

- For details about the supported transceivers, cable types, and connectivity specifications, refer to [“GigaVUE-OS Compatibility and Interoperability Matrix”](#).

BiDi Optics Considerations

There are several nuances to consider due to the complexity in 40Gb BiDi technology. Because of the nature of 40Gb BiDi technology, the same BiDi optic (Full Duplex or RX-only) cannot be used in all of the following situations. For example:

- On SPAN sessions, RX-only BiDi optics cannot be used. Full Duplex BiDi optics must be used.
- When receiving traffic from network links, RX-only BiDi optics must be used due to the way traffic is multiplexed over the fiber pair in 40Gb BiDi technology.
- When deploying over inline 40Gb BiDi links, Full Duplex BiDi optics must be used.
- When connecting two GigaVUE TA Series nodes through a cascade connection, Full Duplex BiDi optics must be used for the tool port. The network port may be either Full Duplex or RX-only BiDi optics.
- When stacking multiple GigaVUE TA Series nodes, 40Gb BiDi optics must not be used on stack links because the 40Gb BiDi technology is not compatible with the Gigamon stack protocol.

Transceiver Installation Instructions

Gigamon transceivers are keyed and can only be installed in one direction. Transceivers are hot-swappable – they can be installed or removed with the power on or off. Use the following procedures to install and remove SFPs from GigaVUE TA Series node.

IMPORTANT: Always use an ESD-preventive wrist or ankle strap and ensure that it makes good skin contact when installing or removing transceivers.

MPO Cabling

Refer to the following sections for MPO cabling:

- [MPO/MTP 12 Position Fiber Cable for Use with SR4 Transceivers](#)
- [MTP/APC Fiber Cable for Use with QSFP+ PLR4 Transceivers](#)
- [MPO/MTP 24 Position Fiber Cable for Use with SR10 Transceivers](#)

- For details about the supported transceiver, cable type, and connectivity specifications, refer to “[GigaVUE-OS Compatibility and Interoperability Matrix](#)”.
- For details about how to cable GigaVUE TA Series nodes, refer to “[GigaVUE-OS Pluggables Guide](#)”.

MPO/MTP 12 Position Fiber Cable for Use with SR4 Transceivers

This is a female to female Multi-fiber Push On (MPO) / Ultra Polished Connector (UPC) of cable type B. [Figure 18 MPO/MTP 12 Position Fiber Cable](#) provides cabling details for MPO/MTP 12 position fiber cable for use with 40Gb SR4 QSFP+, 40Gb ESR4 QSFP+, and 100Gb ER4 QSFP28 and 100Gb SR4 QSFP28 transceivers.

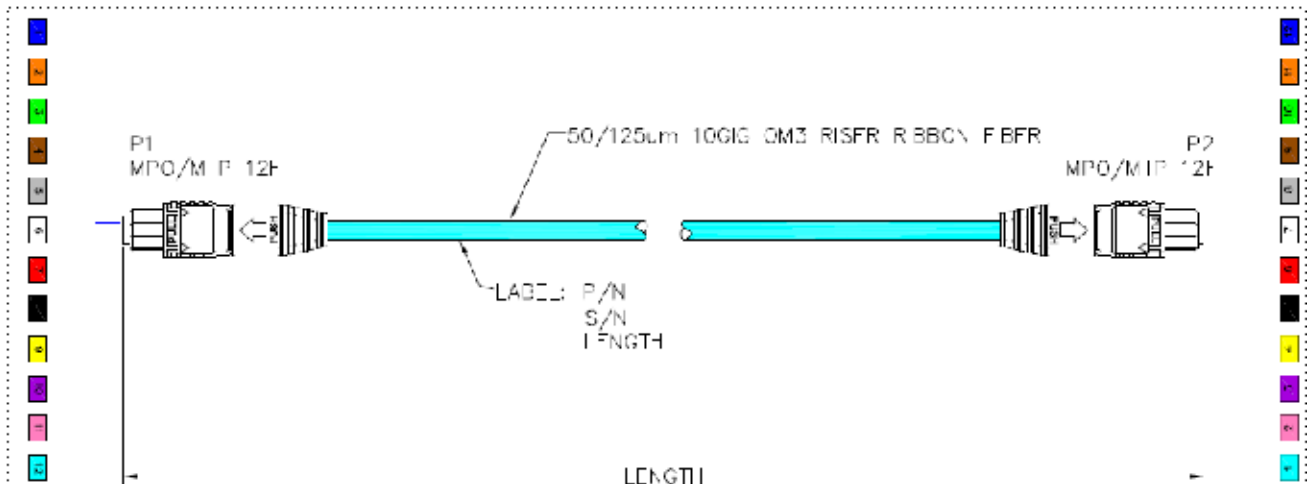

Figure 18 MPO/MTP 12 Position Fiber Cable

MTP/APC 12 Position Fiber Cable for Use with QSFP+ PLR4 Transceivers

The MTP cable is a high performance MPO connector. This is a female to female Angled Polished Connector (APC) of cable type B with an 8-degree angled end-face and a diameter of 9/125 μ m. [Figure 19 MTP/APC Cable](#) provides details for MTP/APC 12 position fiber cable for use with 40Gb QSFP+ PLR4 transceivers on the GigaVUE-TA100 node.

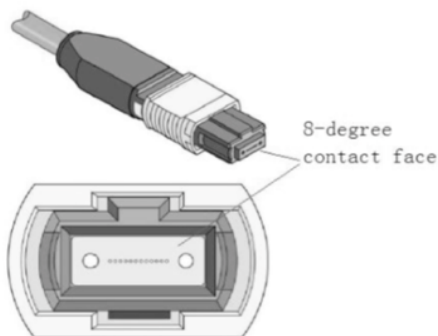

Figure 19 MTP/APC Cable

MPO/MTP 24 Position Fiber Cable for Use with SR10 Transceivers

This is a female to female Ultra Polished Connector (UPC) of cable type B. [Figure 20 MPO/MTP 24 Position Fiber Cable](#) provides cabling details for MPO/MTP 24 position fiber cable for use with 100Gb SR10 CXP transceivers.

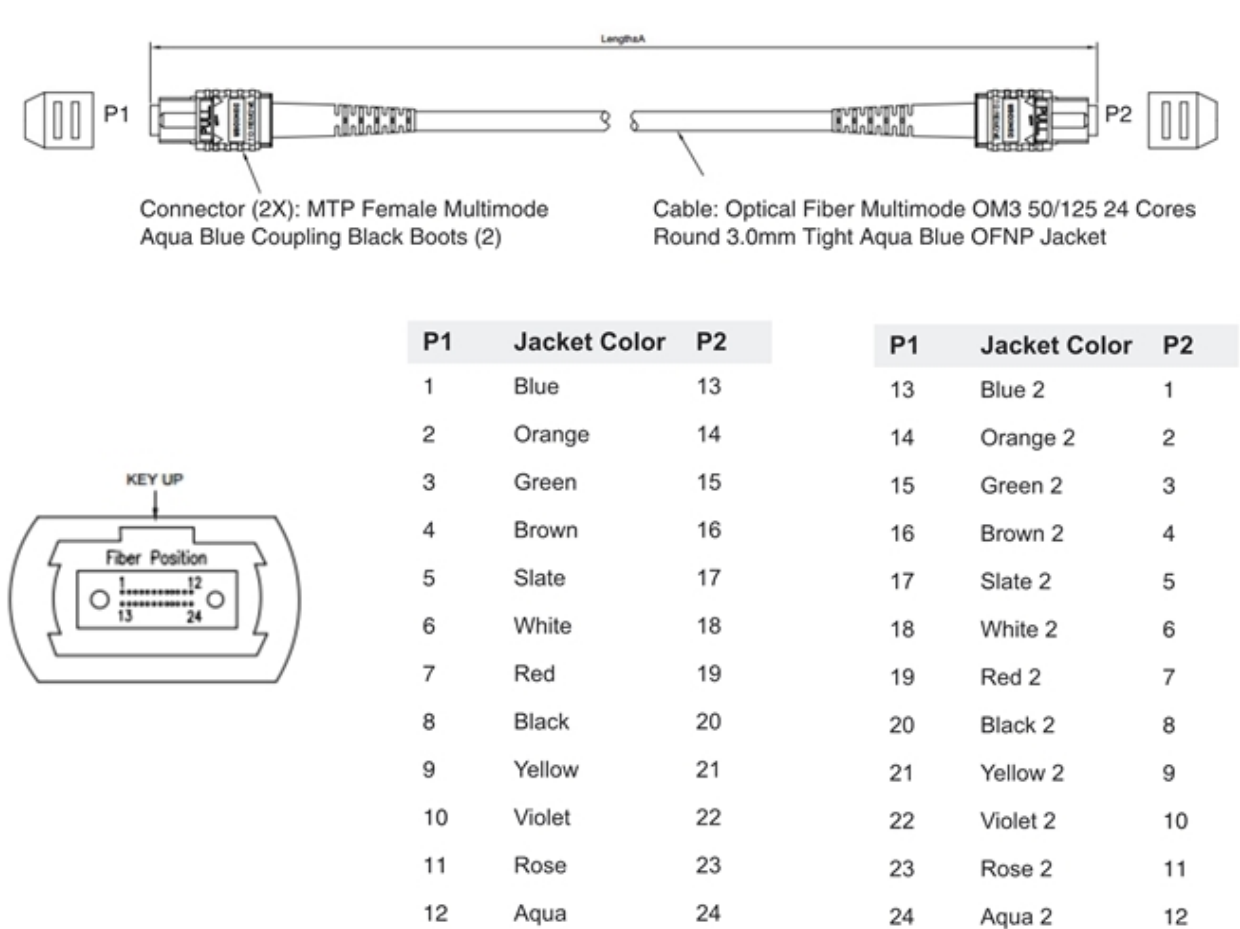

Figure 20 MPO/MTP 24 Position Fiber Cable

GigaVUE[®] TA Series Specifications

This section provides the physical specifications, power requirements and environmental specifications for the GigaVUE TA Series Traffic Aggregation node. Compliance for safety, emissions and immunity are also provided.

Physical Dimensions and Weight

The following table summarizes the dimensions for the GigaVUE TA Series Traffic Aggregation node GigaVUE-TA400:

Product	Height	Width	Depth	Weight (AC Version)
GigaVUE-TA400	1.74in (1RU) (4.42cm)	19.00in (48.26 cm) with ears 17.32in (44cm) without ears	Metal to Metal 21.6in (54.85cm) Including latches 23in (58.42cm)	26lb (11.8kg)

Power Requirements

Each GigaVUE TA Series node come standard with dual, load sharing power supplies. [Table 3: Power Requirements for GigaVUE-TA400](#) summarize the electrical characteristics for the GigaVUE TA Series Traffic Aggregation node GigaVUE-TA400.

NOTE: Refer to [Connecting -48V DC Power Supplies on page 54](#) for instructions on how to connect -48V DC power supplies.

Table 3: Power Requirements for GigaVUE-TA400

Power Configurations	1+1 Power: 2 Power Supply Modules
Max Power Consumption/ Heat Output	1147 Watts; 3601 BTU/hr
AC Power Supply Modules	Min/Max Voltage: 100V-127V AC, 200V-240V AC, 50/60Hz Max PSM Input Current: 13.6A@100V-127V, 9.4A@200V-240V
DC Power Supply Modules	Min/Max Voltage: -40.5 to-72V DC Max PSM Input Current (Steady State): 40A@ 48V DC

Fan Tray Specification for GigaVUE-TA400

The GigaVUE-TA400 uses a fan tray for cooling. The below table summarizes the characteristics of the fan tray.

GigaVUE-TA400 Fan Tray Specifications

Rated Voltage	12V DC
Input Power	Maximum 50.4W
Maximum Speed	27000/23000 RPM
Type	Dual axial flow fans

Environmental Specifications

Environmental Specifications Table 4: Environmental Specifications for GigaVUE TA Series- TA400. summarizes the environmental specifications for GigaVUE TA Series-TA400

Table 4: Environmental Specifications for GigaVUE TA Series- TA400.

Specification	Value
Operating Temperature	32°F to 104°F (0°C to 40°C)
Operating Relative Humidity	10% to 90%, non-condensing
Recommended Storage Temperature	-4°F to 158°F (-20°C to 70°C)
Recommended Storage Relative Humidity	15% to 85%, non-condensing
Altitude	Up to 16405ft (5.00km) for GigaVUE TA Series-TA400

Compliance

This section provides compliance information for GigaVUE TA Series Traffic Aggregation nodes.

- Safety56
- Emissions 57
- Immunity 57
- Environmental58
- BSMI RoHS 58
- VCCI58

Safety

GigaVUE Traffic Aggregation nodes are compliant with the following safety regulations:

- UL 60950-1, 2nd Edition
- UL 62368-1, 2nd Edition (GigaVUE-TA400)
- CAN/CSA C22.2 No. 60950-1-07, 2nd Edition
- CAN/CSA C22.2 No. 62368-1-14, 2nd Edition (GigaVUE-TA400)
- EN 60950-1:2006/A11:2009/A1:2010/A12:2011/A2:2013
- EN 62368-1:2014 (GigaVUE-TA400)
- IEC 60950-1:2005 (2nd Edition) + Am 1:2009 + Am 2:2013
- IEC 62368-1:2014 (GigaVUE-TA400)
- BSMI (GigaVUE-TA100,GigaVUE-TA200 and GigaVUE-TA400)
- CCC, EAC (GigaVUE-TA100,GigaVUE-TA200 and GigaVUE-TA400)

Emissions

GigaVUE TA Series Traffic Aggregation nodes are compliant with the following emissions regulations:

- FCC Part 15, Class A
- VCCI Class A. Refer to [VCCI](#).
- EN 55032/CISPR 32 Class A
- Australia/New Zealand AS/NZS CISPR-32 Class A
- KCC Class A
- BSMI (GigaVUE-TA100, GigaVUE-TA200 and GigaVUE-TA400)
- CCC, EAC (GigaVUE-TA100, GigaVUE-TA200 and GigaVUE-TA400)
- EN 55032:2015+AC:2016, Class A
- EN 61000-3-2:2014, Class A (GigaVUE-TA25E)
- EN 61000-3-3:2013 (GigaVUE-TA25E)
- FCC Class A (GigaVUE-TA25E)
- VCCI Class A (GigaVUE-TA25E)
- CCC GB 9254-2008, Class A (GigaVUE-TA25E)
- BSMI Class A, CNS 13438 (GigaVUE-TA25E)
- EN 55032:2015+AC:2016, Class A (GigaVUE-TA200E)
- EN 61000-3-2:2014, Class (GigaVUE-TA200E)
- EN 61000-3-3:2013 (GigaVUE-TA200E)
- 47 CFR FCC Part 15:2017, Subpart B, Class A CE Mark (GigaVUE-TA200E)

Immunity

GigaVUE TA Series Traffic Aggregation nodes are compliant with the following immunity regulations:

- ETSI EN300 386 V1.6.1:2012 (not applicable on GigaVUE-TA200)
- EN61000-4-2
- EN61000-4-3
- EN61000-4-4
- EN61000-4-5
- EN61000-4-6
- EN61000-4-8
- EN61000-4-11
- EN61000-3-2
- EN61000-3-3
- EN 55024:2010+A1:2015 (GigaVUE-TA25E)
- IEC 61000-4-2/3/4/5/6/8/11 (GigaVUE-TA25E)
- EN 55024:2010+A1:2015 (GigaVUE-TA200E)

- IEC 61000-4-2/3/4/5/6/8/11 (GigaVUE-TA200E)

Environmental

GigaVUE TA Series Traffic Aggregation nodes are compliant with the following environmental regulations:

- EU RoHS 6, EU directive 2011/65/EU
- NEBS Level 3 . Refer to [NEBS Level 3 Compliance](#).

BSMI RoHS

The RoHS label for Taiwan BSMI for GigaVUE-TA400 is as follows:

設備名稱：乙太網交換機 · 型號（型式）：GigaVUE-TA400 Equipment name · Type designation (Type)						
單元 Unit	限制物質及其化學符號 Restricted substances and its chemical symbols					
	鉛 Lead (Pb)	汞 Mercury (Hg)	鎘 Cadmium (Cd)	六價鉻 Hexavalent chromium (Cr ⁶⁺)	多溴聯苯 Polybrominated biphenyls (PBB)	多溴二苯醚 Polybrominated diphenyl ethers (PBDE)
金屬零件 (Metal Parts)	-	○	○	○	○	○
電路模組 (Circuit Modules)	-	○	○	○	○	○
塑膠和聚合物零件 (Plastic and Polymeric parts)	○	○	○	○	○	○
電源元件 (Power Assemblies)	-	○	○	○	○	○

備考1: "超出0.1 wt%" 及 "超出0.01 wt%" 係指限制物質之百分比含量超出百分比含量基準值。
 Note 1: "Exceeding 0.1 wt%" and "exceeding 0.01 wt%" indicate that the percentage content of the restricted substance exceeds the reference percentage value of presence condition.
 備考2: "○" 係指該項限制物質之百分比含量未超出百分比含量基準值。
 Note 2: "○" indicates that the percentage content of the restricted substance does not exceed the percentage of reference value of presence.
 備考3: "-" 係指該項限制物質為排除項目。
 Note 3: The "-" indicates that the restricted substance corresponds to the exemption.

VCCI

The Class A Information Technology Equipment (ITE) label for Japan is as follows:

Type of Equipment	User's Guide
A급 기기 (업무용 방송통신기자재) Class A Equipment (Industrial Broadcasting & Communication Equipment)	이 기기는 업무용(A급) 전자파적합기기로서 판매자 또는 사용자는 이 점을 주의하시기 바라며, 가정외의 지역에서 사용하는 것을 목적으로 합니다. This equipment is Industrial (Class A) electromagnetic wave suitability equipment and seller or user should take notice of it, and this equipment is to be used in the places except for home.

この装置は、クラス A 情報技術装置です。この装置を家庭環境で使用すると電波妨害を引き起こすことがあります。この場合には使用者が適切な対策を講ずるよう要求されることがあります。 **VCCI-A**

この装置は、クラスA機器です。この装置を住宅環境で使用すると電波妨害を引き起こすことがあります。この場合には使用者が適切な対策を講ずるよう要求されることがあります。 **VCCI-A**

警告使用者:
 這是甲類的資訊產品, 在居住的環境中使用時, 可能會造成射頻干擾, 在這種情況下, 使用者會被要求採取某些適當的對策。

この装置は、クラスA機器です。この装置を住宅環境で使用すると電波妨害を引き起こすことがあります。この場合には使用者が適切な対策を講ずるよう要求されることがあります。 **VCCI-A**

Translation of Statement for Class A VCCI-certified Equipment

This is a Class A product based on the standard of the Voluntary Control Council for Interference by Information Technology Equipment (VCCI). If this equipment is used in a domestic environment, radio disturbance may occur, in which case, the user may be required to take corrective action.

Warranty

Gigamon offers a range of premium support and extended services. For details regarding warranty, visit: <https://www.gigamon.com/support/warranty>.

Regulatory Labels

This section provides regulatory labels for GigaVUE® TA Series nodes.

GigaVUE-TA400



GigaVUE-TA400

This area reserved for
Serial Number and Barcode

Change patent numbers to these: 7424018, 7436932, 7440467, 7762047, 7835358, 7889748, 8361266. Other patents pending.

RoHS G430001-01

상호명: Gigamon Inc.
가사제의 명칭 (모델명): GigaVUE-TA400
제조번호:
제조자/제조국: Gigamon Inc./대한민국

FCC: per section 15.19 (2) of 47 CFR part 15 subpart B Class A
This device complies with Part 15 of the FCC rules. Operation is subject to the following two conditions:
1) this device may not cause harmful interference, and
2) this device must accept any interference received, including interference that may cause undesired operation.

CAN ICES-003 (A/NMS-003A)
产品类型/產品型號: GigaVUE-TA400
产品名称/產品名稱: 以太网交换机/乙太網交換機
额定輸入: 200-240Vac, 9-4A, 50/60Hz (每个电源的输入)
制造商/製造商: 奇以电子工业股份有限公司 / 奇以電子工業股份有限公司
此为A级产品, 在生活环境中该产品可能会造成无线电子干扰, 在这种情况下可能需要用户对其它干扰采取确实可行措施。
(警告: 多电源供电, 断开电源时须多电源同时断开)



Supports dual, redundant, hot-swap power supplies.
AC CONFIGURATION:
Input (輸入): 100-127Vac / 200-240Vac, 13.6A/9.4A, 50/60Hz (for each power supply)
Nom. Power Consumption: 1146.3W
Nom. BTU Output: 3926.9 BTU/hr
DC CONFIGURATION:
Input (輸入): 48V **nom**-50V **max** 40A MAX. (for each power supply)
Nom. Power Consumption: 1126.6W
Nom. BTU Output: 3841.7 BTU/hr
CAUTION: TO COMPLETELY REMOVE POWER FROM THE UNIT TO AVOID "SHOCK HAZARD", FIRST TURN OFF POWER AND REMOVE ALL POWER CABLES.
Attention: pour déconnecter complètement l'alimentation électrique de l'équipement il est d'abord nécessaire d'appuyer sur le bouton de coupure puis d'enlever les câbles électriques.

警告: 多電源供電, 断开电源时须多电源同时断开

Made in Taiwan
台灣製造/台灣製造
400637-A0

NEBS Level 3 Compliance

This appendix provides installation instructions for GigaVUE-TA400 Network Equipment-Building System (NEBS) Level 3 compliance.

Installation Instructions GigaVUE-TA400

The following sections detail installation instructions for GigaVUE-TA400

Topics:

Intrabuilding or Intra-connection for GigaVUE-TA400

WARNING: The intra-building ports:

- RJ45: Management port, Console port
- 100G QSFP28: C1-C64
- 400G QSF (optics nameA) D1-D32
- 40G QSFP+: C1-C64

GigaVUE-TA400 equipment or subassembly are suitable for connection to intrabuilding or unexposed wiring or cabling only. The intra-building port(s) of the equipment or subassembly **MUST NOT** be metallically connected to interfaces that connect to the OSP or its wiring. These interfaces are designed for use as intra-building interfaces only (Type 2 or Type 4 ports as described in GR-1089-CORE, Issue 6) and require isolation from the exposed OSP cabling. The addition of Primary Protectors is not sufficient protection in order to connect these interfaces metallically to OSP wiring.

Intrabuilding Ports (RJ45)

WARNING: The intrabuilding ports (RJ45) shall be connected to shielded and grounded cables at both ends.

Class A2 Voltage Accessibility

The GigaVUE-TA400 shall be located in a restricted access location where only crafts personnel are allowed access.

Class B Voltage Accessibility

The GigaVUE-TA400 shall be located in a restricted access location where only crafts personnel are allowed access.

Equipment Grounding Systems

The GigaVUE-TA400 shall be installed and connected to the (CBN).

Communication Equipment Grounding

The GigaVUE-TA400 is suitable for connection to the (Central Office and CPE).

Bonding of Battery Return (BR) Input Terminals

The battery returns of the GigaVUE-TA400 shall be connected as (DC-I).

Connections

- a. The GigaVUE-TA400 shall be grounded via a copper ground conductor #6 AWG for CPE installation.
- b. All bare grounding connection points to the GigaVUE-TA400 shall be cleaned and coated with an antioxidant solution before connections are made.
- c. All surfaces on the GigaVUE-TA400 that are unplated shall be brought to a bright finish and treated with an antioxidant solution before connections are made.
- d. All non-conductive surfaces on the GigaVUE-TA400 shall be removed from all threads and connection points to ensure electrical continuity.
- e. Multiple connectors shall not be secured by the same bolt assemblies.
- f. Unplated connection surfaces that are to be intentionally joined to form a bonding or grounding path shall be brought to a bright finish and then coated with an antioxidant before they are joined (electrical connections).
- g. Listing fasting hardware shall be compatible with materials being joined and shall preclude loosening deterioration, and electrochemical corrosion of the hardware and joined materials.
- h. Non-conductive coatings (such as paint, lacquer, and enamel) on the equipment to be bonded or grounded shall be removed from threads and other contact surfaces to assure electrical continuity.

- i. GigaVUE-TA400 utilizes a Spade width 0.32in/.81cm with a Standard Wire 14-16 (AWG) that utilizes 5in-lbs of torque to secure it to the frame and EUT. Only listed two-hole compression-type connectors shall be used in making connection to flat surfaces (such as bus bars, frames, racks, or cabinets). Torquing and bolts assembly requirements for securing the connector shall be as specified by the connector supplier.
- j. Anti-rotation devices, such as lock washers, will be used on grounding lugs to minimize the possibility of loosening from rotation during installation and maintenance activities.

Input AC/DC Voltage

The GigaVUE-TA400 is capable of operating input 100-240V AC or -48V DC.

Commercial Power Ports

The manufacturer recommends that Surge Protection Device (SPD) is intended to be used with AC-power equipment. The SPD, if used, is installed at the AC power entrance (Refer to definition in the NEC).

Maintenance

CAUTION: Remove all power sources before servicing. (TO COMPLETELY REMOVE POWER FROM THE UNIT, FIRST TURN OFF THE POWER SWITCH AND REMOVE BOTH POWER CABLES).

Maintenance

ATTENTION : Retirez toutes les sources d'alimentation avant de procéder à l'entretien. (POUR RETIRER COMPLÈTEMENT L'ALIMENTATION DE L'APPAREIL, ÉTEIGNEZ D'ABORD L'INTERRUPTEUR D'ALIMENTATION, PUIS RETIREZ LES DEUX CÂBLES ÉLECTRIQUES).

Additional Sources of Information

This appendix provides additional sources of information. Refer to the following sections for details:

- [Documentation](#)
- [Documentation Feedback](#)
- [Contact Technical Support](#)
- [Contact Sales](#)
- [The VUE Community](#)

Documentation

This table lists all the guides provided for GigaVUE TA Series software and hardware. The first row provides an All-Documents Zip file that contains all the guides in the set for the release.

NOTE: In the online documentation, view [What's New](#) to access quick links to topics for each of the new features in this Release; view [Documentation Downloads](#) to download all PDFs.

Table 1: Documentation Set for Gigamon Products

GigaVUE TA Series 6.7 Hardware and Software Guides
<p>DID YOU KNOW? If you keep all PDFs for a release in common folder, you can easily search across the doc set by opening one of the files in Acrobat and choosing Edit > Advanced Search from the menu. This opens an interface that allows you to select a directory and search across all PDFs in a folder.</p>
<p>Hardware</p> <p>how to unpack, assemble, rackmount, connect, and initially configure ports the respective GigaVUE TA Series devices; reference information and specifications for the respective GigaVUE TA Series devices</p>
GigaVUE-HC1 Hardware Installation Guide
GigaVUE-HC3 Hardware Installation Guide
GigaVUE-HC1-Plus Hardware Installation Guide
GigaVUE-HCT Hardware Installation Guide
GigaVUE-TA25 Hardware Installation Guide
GigaVUE-TA25E Hardware Installation Guide
GigaVUE-TA100 Hardware Installation Guide
GigaVUE-TA200 Hardware Installation Guide

GigaVUE TA Series 6.7 Hardware and Software Guides

GigaVUE-TA200E Hardware Installation Guide

GigaVUE-TA400 Hardware Installation Guide

GigaVUE-OS Installation Guide for DELL S4112F-ON

G-TAP A Series 2 Installation Guide

GigaVUE M Series Hardware Installation Guide

GigaVUE-FM Hardware Appliances Guide

Software Installation and Upgrade Guides

GigaVUE-FM Installation, Migration, and Upgrade Guide

GigaVUE-OS Upgrade Guide

GigaVUE V Series Migration Guide

Fabric Management and Administration Guides

GigaVUE Administration Guide

covers both GigaVUE-OS and GigaVUE-FM

GigaVUE Fabric Management Guide

how to install, deploy, and operate GigaVUE-FM; how to configure GigaSMART operations; covers both GigaVUE-FM and GigaVUE-OS features

Cloud Guides

how to configure the GigaVUE Cloud Suite components and set up traffic monitoring sessions for the cloud platforms

GigaVUE V Series Applications Guide

GigaVUE V Series Quick Start Guide

GigaVUE Cloud Suite Deployment Guide - AWS

GigaVUE Cloud Suite Deployment Guide - Azure

GigaVUE Cloud Suite Deployment Guide - OpenStack

GigaVUE Cloud Suite Deployment Guide - Nutanix

GigaVUE Cloud Suite Deployment Guide - VMware (ESXi)

GigaVUE Cloud Suite Deployment Guide - VMware (NSX-T)

GigaVUE Cloud Suite Deployment Guide - Third Party Orchestration

Universal Cloud TAP - Container Deployment Guide

Gigamon Containerized Broker Deployment Guide

GigaVUE TA Series 6.7 Hardware and Software Guides	
GigaVUE Cloud Suite Deployment Guide - AWS Secret Regions	
GigaVUE Cloud Suite Deployment Guide - Azure Secret Regions	
Reference Guides	
GigaVUE-OS CLI Reference Guide	library of GigaVUE-OS CLI (Command Line Interface) commands used to configure and operate GigaVUE HC Series and GigaVUE TA Series devices
GigaVUE-OS Security Hardening Guide	
GigaVUE Firewall and Security Guide	
GigaVUE Licensing Guide	
GigaVUE-OS Cabling Quick Reference Guide	guidelines for the different types of cables used to connect Gigamon devices
GigaVUE-OS Compatibility and Interoperability Matrix	compatibility information and interoperability requirements for Gigamon devices
GigaVUE-FM REST API Reference in GigaVUE-FM User's Guide	samples uses of the GigaVUE-FM Application Program Interfaces (APIs)
Release Notes	
GigaVUE-OS, GigaVUE-FM, GigaVUE-VM, G-TAP A Series, and GigaVUE Cloud Suite Release Notes	new features, resolved issues, and known issues in this release ; important notes regarding installing and upgrading to this release
NOTE:	Release Notes are not included in the online documentation.
NOTE:	Registered Customers can log in to My Gigamon to download the Software and Release Notes from the Software and Docs page on to My Gigamon . Refer to How to Download Software and Release Notes from My Gigamon .
In-Product Help	
GigaVUE-FM Online Help	how to install, deploy, and operate GigaVUE-FM.

How to Download Software and Release Notes from My Gigamon

Registered Customers can download software and corresponding Release Notes documents from the **Software & Release Notes** page on to [My Gigamon](#). Use the My Gigamon Software & Docs page to download:

- Gigamon Software installation and upgrade images,
- Release Notes for Gigamon Software, or
- Older versions of PDFs (pre-v5.7).

To download release-specific software, release notes, or older PDFs:

1. Log in to [My Gigamon](#).
2. Click on the **Software & Release Notes** link.
3. Use the **Product** and **Release** filters to find documentation for the current release. For example, select Product: "GigaVUE-FM" and Release: "5.6," enter "pdf" in the search box, and then click **GO** to view all PDF documentation for GigaVUE-FM 5.6.xx.

NOTE: My Gigamon is available to registered customers only. Newer documentation PDFs, with the exception of release notes, are all available through the publicly available online documentation.

Documentation Feedback

We are continuously improving our documentation to make it more accessible while maintaining accuracy and ease of use. Your feedback helps us to improve. To provide feedback and report issues in our documentation, send an email to: documentationfeedback@gigamon.com

Please provide the following information in the email to help us identify and resolve the issue. Copy and paste this form into your email, complete it as able, and send. We will respond as soon as possible.

Documentation Feedback Form		
About You	Your Name	
	Your Role	
	Your Company	
For Online Topics	Online doc link	<i>(URL for where the issue is)</i>
	Topic Heading	<i>(if it's a long topic, please provide the heading of the section where the issue is)</i>

For PDF Topics	Document Title	<i>(shown on the cover page or in page header)</i>
	Product Version	<i>(shown on the cover page)</i>
	Document Version	<i>(shown on the cover page)</i>
	Chapter Heading	<i>(shown in footer)</i>
	PDF page #	<i>(shown in footer)</i>
How can we improve?	Describe the issue	<i>Describe the error or issue in the documentation. (If it helps, attach an image to show the issue.)</i>
	How can we improve the content? Be as specific as possible.	
	Any other comments?	

Contact Technical Support

For information about Technical Support: Go to **Settings**  > **Support** > **Contact Support** in GigaVUE-FM.

You can also refer to <https://www.gigamon.com/support-and-services/contact-support> for Technical Support hours and contact information.

Email Technical Support at support@gigamon.com.

Contact Sales

Use the following information to Gigamon channel partner or Gigamon sales representatives.

Telephone: +1.408.831.4025

Sales: inside.sales@gigamon.com

Partners: www.gigamon.com/partners.html

Premium Support

Email Gigamon at inside.sales@gigamon.com for information on purchasing 24x7 Premium Support. Premium Support entitles you to round-the-clock phone support with a dedicated Support Engineer every day of the week.

The VÜE Community

The **VÜE Community** is a technical site where Gigamon users, partners, security and network professionals and Gigamon employees come together to share knowledge and expertise, ask questions, build their network and learn about best practices for Gigamon products.

Visit the VÜE Community site to:

- Find knowledge base articles and documentation
- Ask and answer questions and learn best practices from other members.
- Join special-interest groups to have focused collaboration around a technology, use-case, vertical market or beta release
- Take online learning lessons and tutorials to broaden your knowledge of Gigamon products.
- Open support tickets (Customers only)
- Download the latest product updates and documentation (Customers only)

The VÜE Community is a great way to get answers fast, learn from experts and collaborate directly with other members around your areas of interest.

Register today at community.gigamon.com

Questions? Contact our Community team at community@gigamon.com.

Glossary

D

decrypt list

need to decrypt (formerly blacklist)

decryptlist

need to decrypt - CLI Command (formerly blacklist)

drop list

selective forwarding - drop (formerly blacklist)

F

forward list

selective forwarding - forward (formerly whitelist)

L

leader

leader in clustering node relationship (formerly master)

M

member node

follower in clustering node relationship (formerly slave or non-master)

N

no-decrypt list

no need to decrypt (formerly whitelist)

nodecryptlist

no need to decrypt- CLI Command (formerly whitelist)

P

primary source

root timing; transmits sync info to clocks in its network segment (formerly grandmaster)

R

receiver

follower in a bidirectional clock relationship (formerly slave)

S

source

leader in a bidirectional clock relationship (formerly master)